

# VAL2 3/4 C CD

## VALUE Tap Range Lever Bath Taps with Ceramic Disc Valves Chrome



### Features:

- Long life and easy to use 1/4 turn ceramic disc valves
- Metal back nuts for added durability
- Supplied with 3" (76mm) metal lever handles

### Product Certifications:



WRAS Certificate No: 1909901  
WRAS Expiry Date: 30/09/2024

For more products, visit our website:  
<http://www.bristan.com>



### Specification

<b>Product Type:</b>	Bathroom Tap
<b>Main Construction Material:</b>	Brass
<b>Mount Type:</b>	Deck
<b>Handle Type:</b>	Lever
<b>Connection Inlet:</b>	3/4 BSP
<b>Connection Outlet:</b>	Flow Straightener
<b>Number of Tap Holes:</b>	2
<b>Valve/Cartridge Type:</b>	3/4 Ceramic Disc Valve - 1/4 Turn
<b>Plumbing System Requirements:</b>	Suitable for all plumbing systems
<b>Minimum Dynamic Pressure:</b>	0.2 bar
<b>Maximum Dynamic Pressure:</b>	5.0 bar
<b>Maximum Hot Water Temperature: °C</b>	65
<b>Maximum Static Pressure: (bar)</b>	10
<b>Flow Type:</b>	Single
<b>Isolation Included:</b>	No
<b>Check Valve Supplied:</b>	No

### Dimensions (measurements in mm)

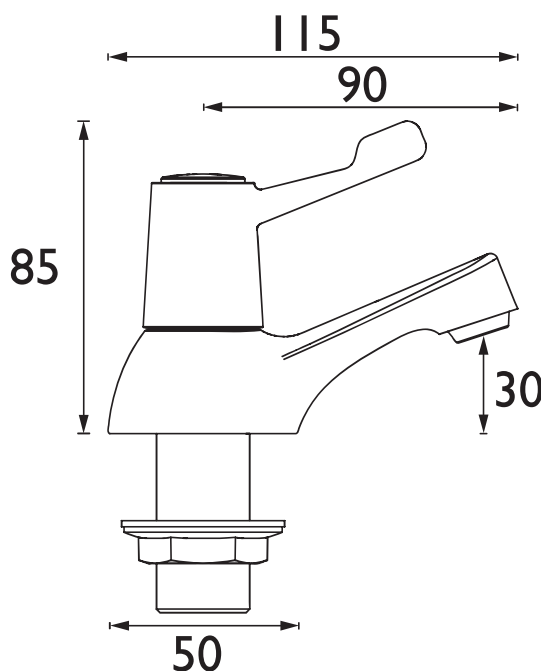

### Flow Rates (l/min)

System Pressure (bar)	0.2	0.5	1	2	3	5
Hot	11.3	18.2	25.9	36.6	42.8	55.0
Cold	11.2	17.8	25.4	36.2	41.9	54.2

## TECHNICAL DATA SHEET



# BRISTAN

D2