

VOGUE UK

TOWEL WARMERS & RADIATORS





VOGUE UK

EST | 1990

Welcome to Vogue UK Ltd - the country's leading manufacturer of heated towel rails, designer radiators and accessories. Established in 1990 within the heart of the West Midlands. Vogue UK continues to design and create more products than any other company in this field, constantly leading the trend by combining fashion with functionality.

Everyone has their own sense of style and that's why Vogue UK has created a range of quintessential products that meet the needs of every interior design style. If you require something unique then our craftsmen can create a design to your exact brief. As Vogue UK have been creating towel warmers and designer radiators since 1990 the company has built an extensive portfolio of designs and can offer a bespoke service, ideal if you're looking to create an authentic period look or simply match an existing design.

The products designed for you in this brochure and on our website are sure to encompass the perfect design for you... no matter what shape, format, style, size, or finish you're looking for.





## CONTEMPORARY THROUGH TO TRADITIONAL

We've been at the forefront of towel rail and radiator design for 34 years. It's easy to see why.

We work with some of the Britain's leading interior designers who create a portfolio that's unlike anything else. Full of inspiration & innovative design in stunning colours and finishes, we turn heating your room into a style statement.

We know every interior is unique in so many ways and we've created ranges that reflects the style and personality of our homes today. From timeless classics, engineered for modern life, to leading contemporary design that gives you a glimpse of the future - whatever your style, you'll find what's right for you.

**Fashion & functionality, beautifully manufactured.**

### CONTENTS

Contemporary	9 - 52
Ladder Rails	53 - 70
Traditional	71 - 104
Designer Radiators	105 - 124
Electric	125 - 126
Underfloor Heating	127 - 128
Additions & Information	131 - 144
Colours & Finishes	145 - 146

# FOCUS METALLICS

NEW



Focus  
Brushed Bronze



FOCUS - BRUSHED BRASS, BRUSHED BRONZE, GUNMETAL AND SATIN BRUSHED NICKEL  
IN THREE HEIGHTS OF: 800MM, 1200MM & 1800MM. See page 62.



Focus  
Gunmetal

Available with finish matched angled, straight or corner valves and connection tubes/cover plates. See Page 142.



Focus Satin Brushed Nickel

Focus Brushed Bronze

Focus Brushed Brass

Focus Gunmetal

# VOGUE UK

## TOWEL WARMERS & RADIATORS

---

For 2024 you will see our product range of environmentally friendly aluminium expanding. With very high thermal conductivity and excellent corrosion resistance its a perfect material for towel warmers and radiators. Metallic finishes such as brushed bronze and brass are proving to be popular and have been further represented throughout our ranges.

---

The evolution of the heated towel warmer stretches way back into the 1800's. In 1834 a man named Denison Olmstead of New Haven, Connecticut created a heat exchanger for his stove which he described as a 'peculiar kind of apparatus, which I call a radiator'. However, it wasn't until 1855, Franz San Galli of St. Petersburg invented the heating radiator.

So the journey began... the radiator became more popular and spread to every room in the home. Once heating reached the bathroom it became unrealistic for towels to dry and pile-up on the radiator and so, the inevitable arrival of the towel warmer came to pass.

The 1920's saw the first of the cast iron water heated towel warmers, commonly referred to as a 'bath radiator'. Here in the UK, drying racks, heated towel warmers and heated towel bars were seen as luxury items and would only ever be found in homes and hotels of high upstanding social status.

As time passed, new materials became available and our abilities to manipulate and manufacture these materials grew. Materials such as copper, brass, mild steel and stainless steel helped to propel the industry forward.

Arriving in the present day and now we have yet more advancement brought to you by Vogue UK, who for 34 years has been manufacturing and innovating many towel warmer styles and designs for bathroom interior design.

---

# SYMBOLS GUIDE

## BRASS MANUFACTURE

The highest quality brass available in a finish of your choice. Corrosion resistant and provides a superior plated finish. Suitable for all heating and hot water systems.

**Brass manufactured products come with a 30 year quality guarantee.**

Page Symbols



Brass



All Heating Systems



30 Years Guarantee

## STAINLESS STEEL MANUFACTURE

Giving an easy to clean finish that is resistant to corrosion and has a high heat output. Suitable for all heating and hot water systems.

**Stainless Steel products come with a 30 year quality guarantee.**

Page Symbols



Stainless Steel



All Heating Systems



30 Years Guarantee

## MILD STEEL MANUFACTURE

Quality mild steel available in chrome and painted finishes suitable for indirect/closed heating systems. Suitable for closed indirect heating systems.

**Mild Steel products come with a 15 year quality guarantee.**

Page Symbols



Mild Steel



Closed Heating Systems



15 Years Guarantee

## ALUMINIUM MANUFACTURE

Lightweight aluminium provides a quick heat up time, thus allowing for greater efficiency with a low water content. Suitable for all heating and hot water systems.

**Aluminium products come with a 10 year quality guarantee.**

Page Symbols



Aluminium



All Heating Systems



10 Years Guarantee

## ADDITIONAL OPTIONS SYMBOLS



### Electric Only

Can be specified where this symbol is displayed. Please see page 135 for full range and price supplements.



### Heating and Electric

Can be specified where this symbol is displayed. Please see page 135 for full range and price supplements.



### Electric Dryline

Can be specified where this symbol is displayed. Dryline technology, heating via a heater cable. POA



### RAL Colours

Available in RAL colour Chart options. Please see page 146 for colour options and price supplement.



### Stocked Item

The 'Tick' symbol in the product specification tables denotes a stocked item.



### Made-to-order

The 'Handprint' symbol in the product specification tables denotes a made to order product.



### Additional Production Process

The 'Stopwatch' denotes a stocked item that under goes additional production processes to achieve chosen finish.





VOGUE UK

EST | 1990

## CONTEMPORARY

Clean lines, stunning finishes, and amazingly practical too. Make a statement with our range of contemporary designs that are leading the way in modern towel rail and radiator innovation.

The best of contemporary designs are often hard to achieve, yet effortless to look at. At Vogue UK we aim to offer modernity that is less about hype and more about ingrained qualities. The best of finishes on designs that suit contemporary living.

# SIERRA DR040

Unique design and bold tubes, the Sierra provides a statement product and increased towel drying capacity. Available in an Anthracite finish, manufactured in high quality mild steel. Prices shown are for central heating models.



For valves and electric elements please see the Additions section - VL003 pictured.

MS C E D 15

## SIERRA

Tube □ 35 x 35 + 60 x 12mm	Dimensions (mm)			Bar Config	Pipe Centres	Element Wattage	ΔT 50°C Watts/BTUs	ΔT 60°C BTUs	£ ex VAT Anthracite	£ inc VAT Anthracite	Stock Info
	H	W	D								
DR040	850	500	125	2+3+3	300	150	524 / 1788	2260	343.00	411.60	✓
DR040	1200	500	125	2+3+3+3	300	200	683 / 2330	2946	446.00	535.20	✓
DR040	1550	500	125	3+3+4+6	300	300	966 / 3296	4166	588.00	705.60	✓

# MARINE DR009

Marines' innovative design is a focal point for any bathroom. The looped horizontal rails maximise both heat output and hanging space. Manufactured from high quality mild steel. Prices shown are for chrome finished for central heating models.



For valves and electric elements please see the Additions section - VL003 pictured.

MS C E D 15

## MARINE

Tube Ø 19 + 32mm	Dimensions (mm)			Bar Config	Pipe Centres	Element Wattage	ΔT 50°C		ΔT 60°C	£ ex VAT	£ inc VAT	Stock Info
	H	W	D				Watts	BTUs	BTUs	Chrome	Chrome	
DR009	1400	600	177	25	110	400	767	2617	3308	739.00	886.80	✓

# ARC MATT BLACK MD065

A matt black statement piece available in three size options. Manufactured from high quality mild steel. Prices shown are for central heating models in the matt black finish.



For valves and electric elements please see the Additions section - VL014 pictured.

MS C E D 15

## ARC MATT BLACK

Tube Ø 32mm □ 40 x 18mm

	Dimensions (mm)			Bar Config	Pipe Centres	Element Wattage	ΔT 50°C Watts/BTUs	ΔT 60°C BTUs	£ ex VAT Matt Black	£ inc VAT Matt Black	Stock Info
	H	W	D								
MD065	828	500	95	3-3-4	430	150	290 / 989	1254	325.00	390.00	✓
MD065	1200	500	95	3-4-4-4	430	300	432 / 1474	1868	412.00	494.40	✓
MD065	1800	500	95	3-3-3-4-4-4	430	400	614 / 2095	2654	520.00	624.00	✓

# ARC MD065

Arc has it all, ample towel hanging space and good heat output. Manufactured from high quality mild steel. Prices shown are for central heating models in a chrome finish, please see pages 145 & 146 for finishes and colour options.

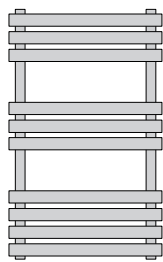

828mm

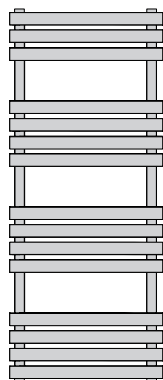

1200mm

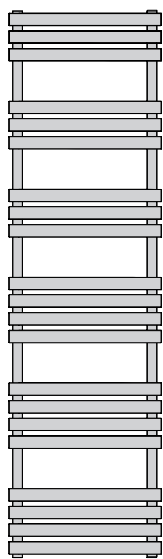

1800mm



Curved Bars



For valves and electric elements please see the Additions section - VL014 pictured.



**MILD STEEL**  
SUPPLEMENTS £ = Chrome + >

Gold Pricing POA



Bright Nickel:



+ £221.00 ex VAT  
+ £265.20 inc VAT

Brushed Nickel:



+ £309.00 ex VAT  
+ £370.80 inc VAT

## ARC

Tube Ø 32mm □ 40 x 18mm

	Dimensions (mm)			Bar Config	Pipe Centres	Element Wattage	ΔT 50°C Watts/BTUs	ΔT 60°C BTUs	£ ex VAT Chrome	£ inc VAT Chrome	Stock Info
	H	W	D								
MD065	828	500	95	3-3-4	430	150	232 / 792	1001	389.00	466.80	✓
MD065	1200	500	95	3-4-4-4	430	300	346 / 1181	1492	500.00	600.00	✓
MD065	1800	500	95	3-3-3-4-4-4	430	400	491 / 1675	2118	627.00	752.40	✓

# CONTRAST MD079

Contrasting design with square mitred outer tubes and round cross bars. The Contrast is a hybrid product with 50mm or 450mm centres and the option for an electric element to go up the vertical square tube without the need for a conversion tee for dual fuel models.



For valves and electric elements please see the Additions section - VL003 pictured.

Prices shown are for central heating models.

MS C E D 15

White  
Sparkle  
Textured

Matt  
Black

## CONTRAST

Tube Ø 38mm □ 50mm sq	Dimensions (mm)			Bar Config	Pipe Centres	Element Wattage	ΔT 50°C Watts/BTUs	ΔT 60°C BTUs	£ ex VAT Matt Black or White Sparkle	£ inc VAT Matt Black or White Sparkle	Stock Info
	H	W	D								
MD079	800	500	105-120	3-7	50 / 450	300	447 / 1525	1928	390.00	468.00	✓
MD079	1200	500	105-120	3-5-7	50 / 450	400	628 / 2143	2708	486.00	583.20	✓
MD079	1500	500	105-120	3-4-5-7	50 / 450	600	770 / 2627	3321	552.00	662.40	✓

# GRACE MD067

Understated with great towel hanging functionality, Grace is the epitome of simple chic design. Manufactured from large diameter high quality mild steel. Prices shown are chrome finished for central heating models.



For valves and electric elements please see the Additions section - VL003 pictured.



**MILD STEEL**  
SUPPLEMENTS £ = Chrome + >

Gold Pricing POA



Bright Nickel:



+ £221.00 ex VAT  
+ £265.20 inc VAT

Brushed Nickel:



+ £309.00 ex VAT  
+ £370.80 inc VAT

## GRACE

Tube Ø 38mm

	Dimensions (mm)			Bar Config	Pipe Centres	Element Wattage	ΔT 50°C Watts/BTUs	ΔT 60°C BTUs	£ ex VAT Chrome	£ inc VAT Chrome	Stock Info
	H	W	D								
MD067	800	500	100	3	462	100	140 / 478	604	270.00	324.00	✓
MD067	1200	500	100	4	462	125	199 / 679	858	301.00	361.20	✓

# PURE MD037

Pure high quality elegance. This hand-crafted towel rail is manufactured in brass and chromed to a mirror finish. Bespoke finishes are available at an additional cost. A perfect size for smaller areas where space is at a premium and quality a must.



Image showing Brushed Bronze finish.



For valves and electric elements please see the Additions section - VL003 pictured.



Suitable for all heating and hot water systems. Prices shown are for chrome finished. The image shows Antique Bronze finish, Please see pages 145 & 146 for finishes and colour options.

## PURE

Tube Ø 25.4 + 19mm

	Dimensions (mm)			Bar Config	Pipe Centres	Element Wattage	ΔT 50°C Watts/BTUs	ΔT 60°C BTUs	£ ex VAT Chrome	£ INC Chrome	Stock Info
	H	W	D								
MD037	700	425	75	4	400	75	106 / 362	457	737.00	884.40	

# AMIE CN065

A contemporary chrome oval tube towel warmer that can be left or right hand mounted. Manufactured from high quality mild steel, please see pages 145 & 146 for finishes and colour options. Prices shown are for chrome finished central heating models.



For valves and electric elements please see the Additions section - VL003 pictured.



**MILD STEEL SUPPLEMENTS** £ = Chrome + >

Gold Pricing POA



Bright Nickel:

+ £221.00 ex VAT  
+ £265.20 inc VAT



Brushed Nickel:

+ £309.00 ex VAT  
+ £370.80 inc VAT



## AMIE

Tube Ø 25 x 50mm oval  
□ 30 x 30 sq

	Dimensions (mm)			Bar Config	Pipe Centres	Element Wattage	ΔT 50°C Watts/BTUs	ΔT 60°C BTUs	£ ex VAT Chrome	£ inc VAT Chrome	Stock Info
	H	W	D								
CN065	1200	500	125-137	3-3-3	80	200	237 / 809	1022	468.00	561.60	✓
CN065	1500	500	125-137	3-3-3-3	80	400	309 / 1054	1333	533.00	639.60	✓

# CHIC MD046

Chic gives ultimate versatility allowing towels to be accessed from the side. This practical and stylish design is available chrome plated. Manufactured from high quality Mild Steel which can be mounted to the left or right.



For valves and electric elements please see the Additions section - VL014 pictured.



**MILD STEEL**  
SUPPLEMENTS £ = Chrome + >

Gold Pricing POA



Bright Nickel:



+ £221.00 ex VAT  
+ £265.20 inc VAT

Brushed Nickel:



+ £309.00 ex VAT  
+ £370.80 inc VAT

## CHIC

Tube □ 30 x 40 sq  
Ø 22mm

	Dimensions (mm)			Bar Config	Pipe Centres	Element Wattage	ΔT 50°C Watts/BTUs	ΔT 60°C BTUs	£ ex VAT Chrome	£ inc VAT Chrome	Stock Info
	H	W	D								
MD046	1200	500	85	3-3-3-3-3	100	150	282 / 962	1216	368.00	441.60	✓

# KEYS II CN030

A contemporary, minimalist design with crisp clean lines. Keys II allows towels to be effortlessly hung onto the rails from the left or right hand side. Manufactured from high quality mild steel, chromed to a mirror finish. Stainless Steel version available on request.



For valves and electric elements please see the Additions section - VL014 pictured.



**MILD STEEL**  
SUPPLEMENTS £ = Chrome + >

Gold Pricing POA



Bright Nickel:



+ £221.00 ex VAT  
+ £265.20 inc VAT

Brushed Nickel:



+ £309.00 ex VAT  
+ £370.80 inc VAT

## KEYS II

Tube □ 30 x 40 sq	Dimensions (mm)			Bar Config	Pipe Centres	Element Wattage	ΔT 50°C Watts/BTUs	ΔT 60°C BTUs	£ ex VAT Chrome	£ inc VAT Chrome	Stock Info
	H	W	D								
CN030	1080	500	141	6	50	150	392 / 1338	1691	522.00	626.40	✓
CN030	1460	500	141	8	50	200	524 / 1788	2260	690.00	828.00	✓

# AQUILA DR016

Rectangular tube towel rail provides ample space and heat for warming or drying towels. The design allows you to slide them into place from either the left or right. Manufactured from high quality Mild Steel and finished in Chrome.



For valves and electric elements please see the Additions section - VL014 pictured.



## AQUILA CHROME

Tube □ 40 x 10 + 30 x 30mm	Dimensions (mm)			Bar Config	Pipe Centres	Element Wattage	ΔT 50°C Watts/BTUs	ΔT 60°C BTUs	£ ex VAT Chrome	£inc VAT Chrome	Stock Info
	H	W	D								
DR016	1200	500	118	3-3-3-3-3	60	150	354 / 1208	1527	522.00	626.40	✓
DR016	1400	600	118	3-3-3-3-3-3	60	200	436 / 1488	1880	577.00	692.40	✓

# AQUILA MATT BLACK DR016

This towel rail can be installed either left or right handed. The open ended rail allows towels to be hung effortlessly from both sides providing you with flexible convenience to suit your room. For a contemporary feel, Aquila is presented here in Matt Black.



For valves and electric elements please see the Additions section - VL014 pictured.



## AQUILA MATT BLACK

Tube □ 40 x 10 + 30 x 30mm	Dimensions (mm)			Bar Config	Pipe Centres	Element Wattage	ΔT 50°C Watts/BTUs	ΔT 60°C BTUs	£ ex VAT Matt Black	£ inc VAT Matt Black	Stock Info
	H	W	D								
DR016	1200	500	118	3-3-3-3-3	60	150	442 / 1508	1911	414.00	496.80	✓
DR016	1400	600	118	3-3-3-3-3-3	60	200	545 / 1859	2355	464.00	556.80	✓

# SMOOTH CN035

Smooth combines excellent towel hanging space with high heat output and eye catching design. Manufactured from high quality Mild Steel. Prices shown are Chrome finished for central heating systems.



For valves and electric elements please see the Additions section - VL003 pictured.



**MILD STEEL**  
SUPPLEMENTS £ = Chrome + >

Gold Pricing POA



Bright Nickel:  
+ £221.00 ex VAT  
+ £265.20 inc VAT



Brushed Nickel:  
+ £309.00 ex VAT  
+ £370.80 inc VAT

## SMOOTH

Tube Ø 32mm + 22mm

	Dimensions (mm)			Bar Config	Pipe Centres	Element Wattage	ΔT 50°C Watts/BTUs	ΔT 60°C BTUs	£ ex VAT Chrome	£ inc VAT Chrome	Stock Info
	H	W	D								
CN035	800	400	94	9	368	100	163 / 556	703	489.00	586.80	✓
CN035	800	500	94	9	468	125	189 / 645	815	503.00	603.60	✓
CN035	1200	400	94	13	368	150	235 / 802	1014	613.00	735.60	✓
CN035	1200	500	94	13	468	150	271 / 925	1169	637.00	764.40	✓

# RHOMBA AU039

A simple design with a refined visual difference, where the framework creates an angular contemporary form. The Rhomba, diamond section towel rail has been created for bathrooms with timeless interiors. Textured Black, Grey and Matt Bronze options.



For valves and electric elements please see the Additions section - VL003 pictured.

AL H E D 10

Textured Black

Textured Grey

Matt Bronze

## RHOMBA

Tube $\diamond$ 30 x 30 + 20 x 20mm	Dimensions (mm)			Bar Config	Pipe Centres	Element Wattage	$\Delta T$ 50°C Watts/BTUs	$\Delta T$ 60°C BTUs	£ ex VAT Black / Grey	£ inc VAT Black / Grey	£ ex VAT Bronze	£ inc VAT Bronze	Stock Info
	H	W	D										
AU039	800	497	104-124	6	455	200	232 / 792	1003	538.72	646.46	564.37	677.24	✓
AU039	1200	497	104-124	8	455	400	328 / 1119	1418	731.36	877.63	766.21	919.45	✓
AU039	1600	497	104-124	10	455	600	424 / 1447	1833	913.30	1095.96	956.80	1148.16	✓

# QUADRATE MD074

Quadrate has 50mm vertical tubes and crisp, sleek edges, which would suit any modern bathroom setting. Available in a range of heights and widths. Manufactured from high quality Mild Steel. Prices are for Chrome central heating models.



For valves and electric elements please see the Additions section - VL014 pictured.



**MILD STEEL SUPPLEMENTS** £ = Chrome + >

Gold Pricing POA



Bright Nickel:



+ £221.00 ex VAT  
+ £265.20 inc VAT

Brushed Nickel:



+ £309.00 ex VAT  
+ £370.80 inc VAT

## QUADRATE

Tube □ 50sq + 30mm sq

	Dimensions (mm)			Bar Config	Pipe Centres	Element Wattage	ΔT 50°C Watts/BTUs	ΔT 60°C BTUs	£ ex VAT Chrome	£ inc VAT Chrome	Stock Info
	H	W	D								
MD074	800	500	105	3-3-3	450	150	271 / 925	1169	451.00	541.20	✓
MD074	800	600	105	3-3-3	550	200	310 / 1058	1337	473.00	567.60	✓
MD074	1200	500	105	3-4-7	450	300	416 / 1419	1794	587.00	704.40	✓
MD074	1200	600	105	3-4-7	550	300	477 / 1628	2057	625.00	750.00	✓
MD074	1600	500	105	3-3-3-5-5	450	400	561 / 1914	2419	723.00	867.60	✓
MD074	1600	600	105	3-3-3-5-5	550	600	645 / 2201	2782	772.00	926.40	✓

# QUADRATE HARMONIQUE MD078

A striking, functional product with high heat output. The square tubing gives a contemporary look for a clean profile. Manufactured from high quality Mild Steel. Prices are Chrome framed with a white radiator to suit central heating models.



For valves and electric elements please see the Additions section - VL014 pictured.



Please Note: Colour option only applies to the inset radiator, not the frame.

## QUADRATE HARMONIQUE

Tube □ 50sq + 30mm sq	Dimensions (mm)			Bar Config	Pipe Centres	Element Wattage	ΔT 50°C Watts/BTUs	ΔT 60°C BTUs	£ ex VAT Chrome	£ inc VAT Chrome	Stock Info
	H	W	D								
MD078	1200	500	105-120	7	450	400	1003 / 3422	4326	688.00	825.60	✓

# RUBIK MD038

Simple and beautiful, the rectangular Stainless Steel tube is built to last. The Rubik comes in Polished Stainless Steel as standard. Stainless Steel construction is suitable for all hot water systems. Please see pages 145 & 146 for other finish and colour options.



For valves and electric elements please see the Additions section - VL014 pictured.



## RUBIK

Tube □ 30 x 20mm sq	Dimensions (mm)			Bar Config	Pipe Centres	Element Wattage	ΔT 50°C Watts/BTUs	ΔT 60°C BTUs	£ ex VAT Polished	£ inc VAT Polished	Stock Info
	H	W	D								
MD038	800	500	80	3-6-3	470	200	404 / 1378	1742	1078.00	1293.60	👇
MD038	1200	500	80	4-10-4	470	300	607 / 2071	2618	1386.00	1663.20	👇
MD038	1500	500	80	4-7-7-4	470	300	747 / 2549	3222	1635.00	1962.00	👇

# IDEAL MD055

A contemporary, minimalist design with crisp edges and clean lines. The Ideal is manufactured in high quality Stainless Steel, which is polished to perfection. Stainless Steel construction is suitable for all hot water systems.



For valves and electric elements please see the Additions section - VL014 pictured.



## IDEAL

Tube □ 30 x 20mm sq	Dimensions (mm)			Bar Config	Pipe Centres	Element Wattage	ΔT 50°C Watts/BTUs	ΔT 60°C BTUs	£ ex VAT Polished	£ inc VAT Polished	Stock Info
	H	W	D								
MD055	900	500	100	3-3	470	100	281 / 959	1212	681.00	817.20	✓
MD055	1200	500	100	4-4	470	125	375 / 1280	1617	763.00	915.60	✓
MD055	1500	500	100	5-5	470	150	469 / 1600	2023	894.00	1072.80	✓

# SERENE MD049

The Serene is just that. A well balanced design which maximises hanging space. A perfect towel warmer for contemporary kitchens and bathrooms alike. Square tubes finished with a choice of Chrome or Contemporary Finishes. Prices are for central heating models.



Contemporary Colour Finishes



Colours are an additional production process.

See the Additions section - VL014 pictured.

**MILD STEEL SUPPLEMENTS** £ = Chrome + >

Gold Pricing POA



Bright Nickel:



+ £221.00 ex VAT  
+ £265.20 inc VAT

Brushed Nickel:



+ £309.00 ex VAT  
+ £370.80 inc VAT

## SERENE

Tube □ 25 + 30mm sq	Dimensions			Bar Config	Pipe Centres	Element Wattage	ΔT 50°C Watts/BTUs		ΔT 60°C BTUs		£ ex VAT	£ INC	£ ex VAT	£ inc VAT	£ ex VAT	£ inc VAT	Stock
	H	W	D				Chrome	Painted	Chrome	Painted	Chrome	Chrome	White	White	Colours	Colours	Info
MD049	1000	500	85	12	470	150	257 / 877	409 / 1396	1108	1764	373.00	447.60	249.00	298.80	425.00	510.00	✓
MD049	1165	500	85	15	470	200	314 / 1071	420 / 1433	1354	1811	406.00	487.20	273.00	327.60	453.00	543.60	✓
MD049	1165	600	85	15	570	300	365 / 1245	437 / 1491	1574	1885	446.00	535.20	299.00	358.80	495.00	594.00	✓
MD049	1700	500	85	20	470	300	434 / 1481	501 / 1709	1872	2161	521.00	625.20	346.00	415.20	566.00	679.20	✓
MD049	1700	600	85	20	570	400	520 / 1774	601 / 2051	2243	2592	574.00	688.80	381.00	457.20	594.00	712.80	✓

# SQUIRE MD047

Modern looks from this square tubed design brings together aesthetics and practicality. This versatile product will suit any modern bathroom. Chrome or Anthracite textured finish. Prices are for central heating models.

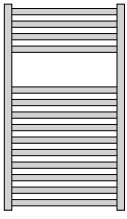

830mm - 14 Bars

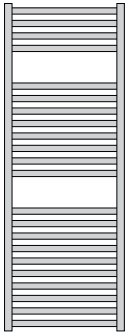

1322mm - 22 Bars

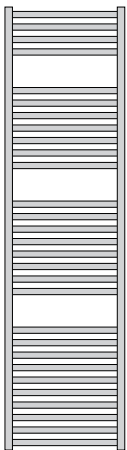

1770mm - 29 Bars

Anthracite  
Textured



See the Additions section - VL014 pictured.



**MILD STEEL SUPPLEMENTS** £ = Chrome + >

Gold Pricing POA



Bright Nickel:

+ £221.00 ex VAT  
+ £265.20 inc VAT



Brushed Nickel:

+ £309.00 ex VAT  
+ £370.80 inc VAT



## SQUIRE

Tube □ 25 + 30mm sq	Dimensions (mm)			Bar Config	Pipe Centres	Element Wattage	ΔT 50°C Watts/BTUs		ΔT 60°C BTUs		£ ex VAT	£ inc VAT	£ ex VAT	£ inc VAT	Stock Info
	H	W	D				Chrome	Painted	Chrome	Painted	Chrome	Chrome	Anthracite	Anthracite	
MD047	830	480	90	4-10	450	150	278 / 949	416 / 1419	1199	1794	321.00	385.20	214.00	256.80	✓
MD047	830	580	90	4-10	550	200	331 / 1129	495 / 1689	1428	2135	351.00	421.20	235.00	282.00	✓
MD047	1322	480	90	4-8-10	450	300	440 / 1501	656 / 2238	1898	2829	425.00	510.00	281.00	337.20	✓
MD047	1322	580	90	4-8-10	550	300	523 / 1784	780 / 2661	2256	3364	457.00	548.40	305.00	366.00	✓
MD047	1770	480	90	4-7-8-10	450	400	581 / 1982	868 / 2962	2506	3743	546.00	655.20	344.00	412.80	✓
MD047	1770	580	90	4-7-8-10	550	600	691 / 2358	1032 / 3521	2980	4451	575.00	690.00	366.00	439.20	✓

## BOXA CN009

Boxa is crafted using large gauge square and rectangular tubing with smooth rounded corners. A perfect blend of form and function. Available in three heights to suit the size of your room. Prices are shown Chrome finished for central heating models.



For valves and electric elements please see the Additions section - VL014 pictured.



15

## BOXA

Tube □ 40 x 40 + 20sq mm

	Dimensions (mm)			Bar Config	Pipe Centres	Element Wattage	ΔT 50°C Watts/BTUs	ΔT 60°C BTUs	£ ex VAT Chrome	£ inc VAT Chrome	Stock Info
	H	W	D								
CN009A - MS	620	450	120	3	410	100	199 / 679	858	481.00	577.20	✓
CN009B - MS	1060	450	120	5	410	150	290 / 989	1251	558.00	669.60	✓
CN009C - MS	1500	450	120	7	410	200	437 / 1491	1885	630.00	756.00	✓

# ZENITH IN007

Zenith is beautifully handcrafted in high quality Stainless Steel and is available in a brushed or polished finish. Stainless Steel is suitable for all heating & hot water systems.



For valves and electric elements please see the Additions section - VL003 pictured.



## ZENITH

Tube □ 40 + 30sq mm	Dimensions (mm)			Bar Config	Pipe Centres	Element Wattage	ΔT 50°C Watts/BTUs	ΔT 60°C BTUs	£ ex VAT Brushed or Polished	£ inc VAT Brushed or Polished	Stock Info
	H	W	D								
IN007	1200	400	90	6	360	125	421 / 1436	1816	1581.00	1897.20	

# GALLANT MD040SS

Crafted in high quality Stainless Steel the Gallant is a bold stylish piece offering crisp right angles to stunning effect. Available in two heights in polished Stainless Steel, suitable for all hot water systems. Please see page 146 for colour options.



For valves and electric elements please see the Additions section - VL014 pictured.



30

## GALLANT

Tube □ 30 + 40 x 20sq mm	Dimensions (mm)			Bar Config	Pipe Centres	Element Wattage	ΔT 50°C Watts/BTUs	ΔT 60°C BTUs	£ ex VAT Brushed or Polished	£ inc VAT Brushed or Polished	Stock Info
	H	W	D								
MD040SS	900	500	97	2-2-4	440	200	458 / 1563	1975	1236.00	1483.20	👤
MD040SS	1200	500	97	2-2-3-4	440	300	624 / 2129	2691	1505.00	1806.00	👤

# GALLANT II MD040MS

The square tubed design is manufactured from high quality Mild Steel and will suit any modern bathroom. Prices shown are for central heating models. Available in Matt Black or Chrome.



For valves and electric elements please see the Additions section - VL003 pictured.



## GALLANT II

Tube Ø 35mm □ 35 + 20mm sq	Dimensions (mm)			Bar Config	Pipe Centres	Element Wattage	ΔT 50°C Watts/BTUs		ΔT 60°C BTUs		£ ex VAT Chrome	£ inc VAT Chrome	£ ex VAT Matt Black	£ inc VAT Matt Black	Stock Info
	H	W	D				Chrome	Painted	Chrome	Painted					
MD040MS	900	500	101	2-2-4	450	200	229 / 781	286 / 976	990	1235	498.00	597.60	205.00	246.00	✓
MD040MS	1200	500	101	2-2-3-4	450	300	312 / 1063	390 / 1331	1347	1682	589.00	706.80	254.00	304.80	✓

# VELA MD048

Rectangular crossbars give a solid feel to this design. Available in two sizes finished in your choice of Chrome, White or a Contemporary Colour. Prices shown are for central heating models.



Contemporary Colour Finishes

- Grey Sparkle Textured
- White Sparkle Textured
- Matt Black
- Satin Black
- Anthracite Textured
- Espresso Gloss
- Mocha Textured
- Cappuccino Textured
- Latte Textured
- Steel Blue
- Moss Green



Colours are an additional production process.



For valves and electric elements please see the Additions section VL003 pictured.

**MILD STEEL SUPPLEMENTS** £ = Chrome + >

Gold Pricing POA



Bright Nickel:

+ £221.00 ex VAT  
+ £265.20 inc VAT



Brushed Nickel:

+ £309.00 ex VAT  
+ £370.80 inc VAT

## VELA

Tube Ø 38mm □ 60 + 10mm	Dimensions			Bar Config	Pipe Centres	Element Wattage	ΔT 50°C Watts/BTUs		ΔT 60°C BTUs		£ ex VAT	£ inc VAT	£ ex VAT	£ inc VAT	£ ex VAT	£ inc VAT	Stock Info
	H	W	D				Chrome	Painted	Chrome	Painted	Chrome	Chrome	White	White	Colours	Colours	
MD048	950	500	101	2-3-4	462	125	246 / 839	289 / 986	1061	1246	399.00	478.80	267.00	320.40	487.00	584.40	✓
MD048	1300	500	101	3-5-5	462	200	330 / 1126	389 / 1327	1423	1678	634.00	760.80	399.00	478.80	670.00	804.00	✓

# VELA FOCUS BRUSHED BRASS MD048

The popular Vela format in the Vogue UK Focus Brushed Brass Finish. This range was requested by designers and can utilise matching valves, connection tubes and cover plates for a complete modern look. Prices shown are for central heating models.



For valves and electric elements please see the Additions section - VL033 pictured.

MS C E D 15

## VELA FOCUS BRUSHED BRASS

Tube Ø 38mm □ 60 + 10mm	Dimensions			Bar Config	Pipe Centres	Element Wattage	ΔT 50°C Watts/BTUs	ΔT 60°C BTUs	£ EX F- Brushed Brass	£ inc VAT F- Brushed Brass	Stock Info
	H	W	D								
MD048	950	500	84	2-3-4	462	125	299 / 1021	1294	549.00	658.80	✓
MD048	1300	500	84	3-5-5	462	200	426 / 1453	1803	769.00	922.80	✓

# VIVID CN021

Vivid is a beautiful minimalistic towel warmer, manufactured from high quality brass. Prices shown are for Chrome heating and hot water systems. Please see pages 145 & 146 for finishes and colour options.



Image showing hand finished in Brushed Brass.



For valves and electric elements please see the Additions section - VL003 pictured.



Mitred Joint.



## VIVID

Tube Ø 25.4 x 22mm

	Dimensions (mm)			Bar Config	Pipe Centres	Element Wattage	ΔT 50°C Watts/BTUs	ΔT 60°C BTUs	£ ex VAT Chrome	£ inc VAT Chrome	Stock Info
	H	W	D								
CN021	750	450	93	4	400	75	121 / 413	522	785.00	942.00	✓
CN021	800	650	93	4	600	100	154 / 525	664	868.00	1041.60	✘
CN021	1250	500	93	6	450	125	201 / 686	867	1008.00	1209.60	✓
CN021	1250	650	93	6	600	125	235 / 802	1014	1027.00	1232.40	✘
CN021	1550	500	93	8	450	150	258 / 880	1113	1173.00	1407.60	✘
CN021	1550	650	93	8	600	150	303 / 1034	1307	1209.00	1450.80	✘

# VIVID II CN029

Vivid II is a simplistic alternative to our Vivid without the mitred corner joints manufactured from high quality brass. Prices shown are in Chrome heating and hot water systems. Please see pages 145 & 146 for finishes and colour options.



For valves and electric elements please see the Additions section - VL003 pictured.



Cropped Joint.



## VIVID II

Tube Ø 25.4	Dimensions (mm)			Bar Config	Pipe Centres	Element Wattage	ΔT 50°C Watts/BTUs	ΔT 60°C BTUs	£ ex VAT Chrome	£ inc VAT Chrome	Stock Info
	H	W	D								
CN029	700	500	94	4	450	75	138 / 471	595	763.00	915.60	👇
CN029	1100	500	94	5	450	125	189 / 645	815	895.00	1074.00	👇
CN029	1400	500	94	6	450	150	232 / 792	1001	1058.00	1269.60	👇

# VIVID INTEGRAL VALVE IVCN021

Vivid IV is a three bar version for additional towel drying capacity. Manufactured from high quality brass with built in integral valves. Prices shown are Chrome finished for all heating and hot water systems. Please see pages 145 & 146 for finishes and colour options.



Image showing Brushed Nickel finish.

Pipe work is hidden in the wall. We recommend using service valves as part of the installation. Not suitable for brick walls.



Cropped Joint.



## VIVID

Tube Ø 25.4mm

	Dimensions (mm)			Bar Config	Pipe Centres	ΔT 50°C Watts/BTUs	ΔT 60°C BTUs	£ ex VAT Chrome	£ inc VAT Chrome	Stock Info
	H	W	D							
IVCN021	400	120	94	3	1150	183 / 624	789	731.00	877.20	

# VIVID INTEGRAL VALVE IVCN021

Vivid IV horizontal is the ideal choice over a bath or underneath a window. The single bar versions are perfect for en-suites and small spaces. Manufactured from high quality brass with built in valves. Please see pages 145 & 146 for finishes and colour options.



Image showing Polished Brass finish.

Pipe work is hidden in the wall. We recommend using service valves as part of the installation. Not suitable for brick walls.



## VIVID

Tube Ø 25.4mm	Dimensions (mm)			Bar Config	Pipe Centres	ΔT 50°C Watts/BTUs	ΔT 60°C BTUs	£ ex VAT Chrome	£ inc VAT Chrome	Stock Info
	H	W	D							
IVCN021 single bar	50	400	94	1	325	21 / 72	91	361.00	433.20	
IVCN021 single bar	50	600	94	1	525	30 / 102	129	374.00	448.80	

# SIMPLICITY INTEGRAL VALVE IVCN026

A more unique option...The vertical heat pole comes with a robe hook to hang your apparel with ease for the luxury of cosy warmth as and when you need it. The ultimate model for settings where wall space is limited.

## Integral Valve Fitting

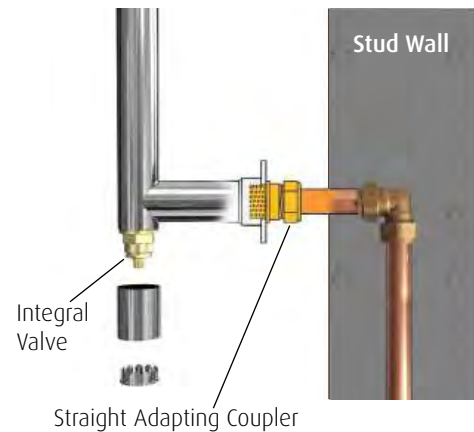

Prices shown are Chrome finished for all heating and hot water systems. Please see pages 145 & 146 for finishes and colour options.



Pipe work is hidden in the wall. We recommend using service valves as part of the installation. Not suitable for brick walls.

## SIMPLICITY INTEGRAL VALVE

Tube Ø 25.4	Dimensions (mm)			Bar Config	Pipe Centres	ΔT 50°C Watts/BTUs	ΔT 60°C BTUs	£ ex VAT Chrome	£ inc VAT Chrome	Stock Info
	H	W	D							
IVCN026	1700	50	115	1	1625	75 / 256	323	681.00	817.20	

# VENTURE CN022

Venture is available in three widths and four heights, with spacious hanging bars. The Romolo bold jointed design suits contemporary interiors. Manufactured from high quality brass, chromed to a mirror finish. Please see pages 145 -146 for finishes and colour options.



For valves and electric elements please see the Additions section - VL003 pictured.



30

## VENTURE

Tube Ø 25.4 x 22mm	Dimensions (mm)			Bar Config	Pipe Centres	Element Wattage	ΔT 50°C Watts/BTUs	ΔT 60°C BTUs	£ ex VAT Chrome	£ inc VAT Chrome	Stock Info
	H	W	D								
CN022	750	450	95	4	400	75	121 / 413	522	910.00	1092.00	✓
CN022	850	650	95	4	600	100	157 / 536	677	952.00	1142.40	👇
CN022	1300	500	95	6	450	125	206 / 703	888	1175.00	1410.00	👇
CN022	1300	650	95	6	600	125	240 / 819	1035	1195.00	1434.00	👇
CN022	1600	500	95	8	450	150	267 / 911	1152	1265.00	1518.00	👇
CN022	1600	650	95	8	600	150	312 / 1065	1346	1391.00	1669.20	👇

# MANTRA V CN075

A simple yet sophisticated piece. With chunky tube creating a robust and full bodied appeal, the Mantra V, will add a high quality and classy statement to your bathroom or en suite.



For valves and electric elements please see the Additions section - VL003 pictured.



## MANTRA V

Tube Ø 32mm + 51mm

	Dimensions (mm)			Bar Config	Pipe Centres	Element Wattage	ΔT 50°C Watts/BTUs	ΔT 60°C BTUs	£ ex VAT Chrome	£ inc VAT Chrome	Stock Info
	H	W	D								
CN075	1240	500	125	14	449	200	408 / 1392	1760	591.00	709.20	✓

# IERI TM014 - BR

The integrated shelf in this curvaceous design has the added benefit of towel stacking as well as plentiful hanging space. Available in two height options to suit your space with an alternative shelf position which is optional on point of order.



For valves and electric elements please see the Additions section - VL003 pictured.



Manufactured from high quality brass and chrome finished, with bespoke finishes available at an additional cost. Please see pages 145 & 146 for finishes and colour options. Prices shown are Chrome finished for central heating models.

Note: Shelf location may vary when specified as electric models. Please speak with our technical team.

## IERI

Tube Ø 25.4 + 22mm	Dimensions (mm)			Bar Config	Face to Face Connections	Element Wattage	ΔT 50°C Watts/BTUs	ΔT 60°C BTUs	£ ex VAT Chrome	£ inc VAT Chrome	Stock Info
	H	W	D								
TM014	750	500	265	4	375	100	219 / 747	944	1143.00	1371.60	👇
TM014	1350	500	265	7	375	200	329 / 1123	1419	1248.00	1497.60	👇

# SOLO TR001-BR

The single shelf towel rack, Solo is an ideal design for limited space. This design provides ease of access to your dry and warm towels. Manufactured from quality brass, chromed to a mirror finish. Prices shown are for Chrome finished Suitable for all heating and hot water systems.



For valves and electric elements please see the Additions section - VL003 pictured.



Manufactured from high quality brass and chrome finished, with bespoke finishes available at an additional cost. Please see pages 145 & 146 for finishes and colour options. Prices shown are chrome finished for central heating models.

## SOLO

Tube Ø 25.4mm

	Dimensions (mm)			Bar Config	Pipe Centres	Element Wattage	ΔT 50°C Watts/BTUs	ΔT 60°C BTUs	£ ex VAT Chrome	£ inc VAT Chrome	Stock Info
	H	W	D								
TR001	263	500	315	5	425	50	126 / 430	543	703.00	843.60	

# BINARY TR002-BR

The double shelf towel rack Binary is perfect for situations where space is at a premium and style is of priority. This clever design allows you to stack, roll or hang your towels, so they are always warm, dry and handy. Manufactured from quality brass, which is Chrome plated to a mirror finish.



For valves and electric elements please see the Additions section - VL003 pictured.



Manufactured from high quality brass and chrome finished, with bespoke finishes available at an additional cost.

Please see pages 145 & 146 for finishes and colour options. Prices shown are chrome finished for central heating models.

## BINARY

Tube Ø 25.4mm

	Dimensions (mm)			Bar Config	Pipe Centres	Element Wattage	ΔT 50°C Watts/BTUs	ΔT 60°C BTUs	£ ex VAT Chrome	£ inc VAT Chrome	Stock Info
	H	W	D								
TR002	275	500	315	9	425	75	224 / 764	966	930.00	1116.00	👇

# TEMPO MD072

A contemporary multirail, with protruding bars for extra towel hanging space. Prices shown are chromed finish for central heating models. Manufactured from high quality mild steel, chromed to a mirror finish.



For valves and electric elements please see the Additions section - VL003 pictured.



## TEMPO

Tube Ø 22 +  
30 x 40mm D Section

	Dimensions (mm)			Bar Config	Pipe Centres	Element Wattage	ΔT 50°C Watts/BTUs	ΔT 60°C BTUs	£ ex VAT Chrome	£ inc VAT Chrome	Stock Info
	H	W	D								
MD072	800	500	170-190	17 + 9	455	150	416 / 1419	1794	281.00	337.20	✓
MD072	1160	500	170-190	25 + 12	455	300	592 / 2020	2553	382.00	458.40	✓

# NEXUS III TM001

High heat output from a radiator combined with a stylish brass frame makes the perfect combination of heat, good looks and versatility to enhance any bathroom or utility room. Prices shown are for central heating models. The inset radiator comes in white as standard.



For valves and electric elements please see the Additions section - VL003 pictured. Prices shown are chrome finished. Please see pages 145 & 146 for finishes and colour options applicable to the tubular frame only.



Please Note: The colour option does not apply to the inset radiator.

## NEXUS III

Tube Ø 25.4 + 15mm	Dimensions (mm)			Bar Config	Pipe Centres	Element Wattage	ΔT 50°C Watts/BTUs	ΔT 60°C BTUs	£ ex VAT Chrome	£ inc VAT Chrome	Stock Info
	H	W	D								
TM001	900	525	142	6	500	400	716 / 2443	3088	1004.00	1204.80	

# HARMONIQUE MD060

A perfect combination for heating and drying. This versatile product will suit any modern bathroom. With a white double panelled radiator as standard and 25mm chrome horizontal tubes. Other radiator colours can be specified, please see page 146 for colour options.



For valves and electric elements please see the Additions section - VL003 pictured



Please Note: Colour option only applies to the inset radiator, not the frame.

**MILD STEEL SUPPLEMENTS** £ = Chrome + >

Frame Gold Pricing POA



Frame Bright Nickel:



+ £221.00 ex VAT  
+ £265.20 inc VAT

Frame Brushed Nickel:



+ £309.00 ex VAT  
+ £370.80 inc VAT

## HARMONIQUE

Tube Ø 25 + 30 x 40mm D Section	Dimensions (mm)			Bar Config	Pipe Centres	Element Wattage	ΔT 50°C Watts/BTUs	ΔT 60°C BTUs	£ ex VAT Chrome	£ inc VAT Chrome	Stock Info
	H	W	D								
MD060	1200	500	93	3-3-3	464	300	834 / 2846	3597	655.00	786.00	✓
MD060	1200	600	93	3-3-3	564	400	1033 / 3525	4455	710.00	852.00	✓
MD060	1500	500	93	3-3-3-3	464	400	1145 / 3907	4938	764.00	916.80	✓
MD060	1500	600	93	3-3-3-3	564	400	1438 / 4906	6202	822.00	986.40	✓

# DÉCOR HARMONIQUE MD094

The Décor Harmonique is a stylish combination towel warmer and radiator. Flat horizontal chrome bars and a white double panel radiator to provide a high heat output. Other radiator colours can be specified, please see page 146 for colour options.



For valves and electric elements please see the Additions section - VL003 pictured



Please Note: Colour option only applies to the inset radiator, not the frame.  
Prices shown are for central heating models.

## DÉCOR HARMONIQUE

Tube Ø 40 x 20 + 40 x 10mm	Dimensions (mm)			Bar Config	Face To Face Connections	Element Wattage	ΔT 50°C Watts/BTUs	ΔT 60°C BTUs	£ ex VAT Chrome	£ inc VAT Chrome	Stock Info
	H	W	D								
MD094	1200	500	159	4	442	200	842 / 2873	3631	727.00	872.40	✓

# ASTUTE CN095

A towel warmer providing great efficiency and easy installation in lightweight but durable aluminium. Available in two heights with your choice of White or Anthracite finish.



For valves and electric elements please see the Additions section - VL003 pictured.

AL H E D 10

## ASTUTE

	Dimensions (mm)			Bar Config	Pipe Centres	Element Wattage	$\Delta T$ 50°C Watts/BTUs	$\Delta T$ 60°C BTUs	£ ex VAT White	£ inc VAT White	£ ex VAT Anthracite	£ inc VAT Anthracite	Stock Info
	H	W	D										
CN095	1200	500	100	10	470	600	778 / 2655	3355	399.00	478.80	410.00	492.00	✓
CN095	1600	500	100	13	470	600	1043 / 3560	4511	451.00	541.20	462.00	554.40	✓

# CONCORD DR041

Resplendent in a durable Focus Brushed Brass finish, Concord is a statement piece to adorn any well dressed bathroom wall. Concord also has great functionality with good heat output and plenty of space to warm towels. Prices shown are for central heating models.



For valves and electric elements please see the Additions section - VL033 pictured.

MS C E D 15

## CONCORD

Tube □ 12 + 24 X Ø 38mm

	Dimensions (mm)			Bar Config	Pipe Centres	Element Wattage	ΔT 50°C	ΔT 60°C	£ ex VAT	£ inc VAT	Stock Info
	H	W	D				Watts/BTUs	BTUs	F- Brushed Brass	F- Brushed Brass	
DR041	800	500	102	2-3-3	450	200	291 / 994	1259	385.00	462.00	✓
DR041	1200	500	102	3-4-5	450	300	437 / 1491	1889	542.00	650.40	✓
DR041	1600	500	102	3-4-4-5	450	300	583 / 1987	2518	741.00	889.20	✓

NEW



Focus Metallics in Gunmetal  
See Page 62.



VOGUE UK

EST | 1990

## LADDER RAILS

Who said being practical had to be boring?

Our range of ladder rails combine function and form effortlessly. You can choose from our inspired range and heating your room and warming your towels need never be dull again.

Ladder type rails, often referred to as a multi-rail, were born out of purpose. These models are the well accepted modern classic, with design credentials built around efficiency and space saving. So, why choose a Vogue UK ladder rail? Our offerings are presented in the latest interiors finishes. We offer full ranges in terms of these finishes, sizes and formats. Importantly, Vogue offer matching accessories for these finishes, creating a more satisfying installed product. Features such as hidden air vents for our 25mm ranges also complete the intended look.

In our eyes service counts for something. We look after all our customers and make sure that our after sales requirements are upheld to the standards of our brand.

# AXIS 22MM WALL MOUNTED MD062

Axis has adjustable brackets through the crossbars, offering freedom and ease of installation. The amount of rails are ideal for optimum efficiency. This contemporary rail is a modern example of proficient design. Prices shown are for Chrome finish, central heating models.



Optional Aroma Plug

Blanking Plug with Aroma Oil Dish

AC035

£12.00 ex VAT

£14.40 inc VAT



For valves and electric elements please see the Additions section - VL003 pictured.



## AXIS

Tube Ø 22 + 30 x 40mm D section	Dimensions (mm)			Bar Config	Pipe Centres	Element Wattage	ΔT 50°C Watts/BTUs	ΔT 60°C BTUs	£ ex VAT Chrome	£ inc VAT Chrome	Stock Info
	H	W	D								
MD062	600	405	90-105	4-8	355	100	172 / 587	744	132.00	158.40	✓
MD062	600	505	90-105	4-8	455	125	208 / 710	900	138.00	165.60	✓
MD062	600	605	90-105	4-8	555	125	245 / 836	1059	144.00	172.80	✓
MD062	800	305	90-105	4-5-5	255	100	167 / 570	722	151.00	181.20	✓
MD062	800	405	90-105	4-5-5	355	100	209 / 713	903	156.00	187.20	✓
MD062	800	505	90-105	4-5-5	455	125	252 / 860	1090	166.00	199.20	✓
MD062	800	605	90-105	4-5-5	555	150	295 / 1007	1276	177.00	212.40	✓
MD062	800	755	90-105	4-5-5	705	200	359 / 1225	1552	196.00	235.20	✓
MD062	1000	305	90-105	4-5-8	255	150	211 / 720	912	162.00	194.40	✓
MD062	1000	405	90-105	4-5-8	355	150	266 / 907	1149	172.00	206.40	✓
MD062	1000	505	90-105	4-5-8	455	200	321 / 1096	1389	187.00	224.40	✓
MD062	1000	605	90-105	4-5-8	555	200	378 / 1288	1632	199.00	238.80	✓
MD062	1200	305	90-105	4-5-12	255	200	257 / 877	1111	184.00	220.80	✓
MD062	1200	405	90-105	4-5-12	355	200	323 / 1102	1396	190.00	228.00	✓
MD062	1200	505	90-105	4-5-12	455	200	391 / 1335	1691	201.00	241.20	✓
MD062	1200	605	90-105	4-5-12	555	300	460 / 1567	1985	221.00	265.20	✓
MD062	1200	755	90-105	4-5-12	705	300	558 / 1904	2412	231.00	277.20	✓
MD062	1400	505	90-105	4-5-5-10	455	300	444 / 1516	1921	224.00	268.80	✓
MD062	1400	605	90-105	4-5-5-10	555	300	521 / 1775	2249	244.00	292.80	✓
MD062	1600	405	90-105	4-5-5-5-9	355	300	433 / 1475	1869	246.00	295.20	✓
MD062	1600	505	90-105	4-5-5-5-9	455	300	522 / 1780	2255	248.00	297.60	✓
MD062	1600	605	90-105	4-5-5-5-9	555	400	613 / 2091	2649	264.00	316.80	✓
MD062	1800	405	90-105	4-5-5-5-13	355	400	474 / 1617	2049	294.00	352.80	✓
MD062	1800	505	90-105	4-5-5-5-13	455	400	571 / 1949	2469	311.00	373.20	✓
MD062	1800	605	90-105	4-5-5-5-13	555	400	671 / 2287	2898	333.00	399.60	✓
MD062	1800	755	90-105	4-5-5-5-13	705	400	836 / 2852	3613	338.00	405.60	✓



For valves and electric elements please see the Additions section - VL003 pictured.

MS C E D 15

## AXIS MATT BLACK

Tube Ø 22 + 30 x 40mm D section	Dimensions (mm)			Bar Config	Pipe Centres	Element Wattage	ΔT 50°C Watts/BTUs	ΔT 60°C BTUs	£ ex VAT Matt Black	£ inc VAT Matt Black	Stock Info
	H	W	D								
MD062	800	505	90-105	4-5-5	455	125	328 / 1119	1414	111.00	133.20	✓
MD062	800	605	90-105	4-5-5	555	150	384 / 1310	1656	122.00	146.40	✓
MD062	1200	505	90-105	4-5-12	455	200	492 / 1678	2121	133.00	159.60	✓
MD062	1200	605	90-105	4-5-12	555	300	576 / 1965	2484	145.00	174.00	✓
MD062	1600	505	90-105	4-5-5-5-9	455	300	644 / 2197	2777	157.00	188.40	✓
MD062	1600	605	90-105	4-5-5-5-9	555	400	754 / 2572	3251	168.00	201.60	✓

# COMBES 22MM WALL MOUNTED MD063

Our Combes offers adjustable brackets through the crossbars also offer freedom and ease of installation. Offering a copious amount of rails for optimum efficiency, this contemporary rail is a modern example of proficient design. The curved version of our MD062. Prices shown are for chromed finish, central heating models.

Optional Aroma Plug

Blanking Plug with Aroma Oil Dish  
AC035  
£12.00 ex VAT  
£14.40 inc VAT

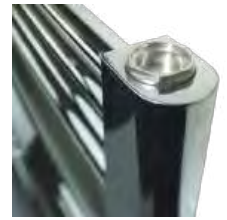

For valves and electric elements please see the Additions section - VL003 pictured.



Showing Curve.

**MILD STEEL SUPPLEMENTS** £ = Chrome + >

Gold Pricing POA



Bright Nickel:



+ £221.00 ex VAT  
+ £265.20 inc VAT

Brushed Nickel:



+ £309.00 ex VAT  
+ £370.80 inc VAT

## COMBES CURVED

Tube Ø 22 + 30 x 40mm D section	Dimensions (mm)			Bar Config	Pipe Centres	Element Wattage	ΔT 50°C Watts/BTUs	ΔT 60°C BTUs	£ ex VAT Chrome	£ inc VAT Chrome	Stock Info
	H	W	D								
MD063	800	505	103-123	4-5-5	455	125	252 / 860	1087	171.00	205.20	✓
MD063	800	605	109-129	4-5-5	555	150	295 / 1007	1272	184.00	220.80	✓
MD063	1000	505	103-123	4-5-8	455	200	308 / 1051	1328	190.00	228.00	✓
MD063	1000	605	109-129	4-5-8	555	200	361 / 1232	1557	204.00	244.80	✓
MD063	1200	505	103-123	4-5-12	455	200	378 / 1290	1630	208.00	249.60	✓
MD063	1200	605	109-129	4-5-12	555	300	443 / 1512	1911	228.00	273.60	✓
MD063	1400	505	103-123	4-5-5-10	455	300	431 / 1471	1859	229.00	274.80	✓
MD063	1400	605	109-129	4-5-5-10	555	300	504 / 1720	2174	247.00	296.40	✓
MD063	1600	505	103-123	4-5-5-5-9	455	300	495 / 1689	2135	256.00	307.20	✓
MD063	1600	605	109-129	4-5-5-5-9	555	400	580 / 1979	2501	270.00	324.00	✓
MD063	1800	505	103-123	4-5-5-5-13	455	400	558 / 1904	2407	317.00	380.40	✓
MD063	1800	605	109-129	4-5-5-5-13	555	400	654 / 2231	2821	340.00	408.00	✓



# FOCUS 25MM WALL MOUNTED MD001

Focus is a range of 25mm tube design towel warmers with high heat output and superior looks. Manufactured from high quality Mild Steel with smooth flat tops and rear air vent. Prices shown are for Chrome or White central heating models. .



## MILD STEEL SUPPLEMENTS

£ = Chrome + >



Gold Pricing POA



Bright Nickel:  
+ £221.00 ex VAT  
+ £265.20 inc VAT



Brushed Nickel:  
+ £309.00 ex VAT  
+ £370.80 inc VAT



Hidden rear air vent  
for integral look and feel.



For valves and electric  
elements please see the  
Additions section.

For other colour options see Focus Colours on Page 61.



## FOCUS STRAIGHT

Tube Ø 25 + 30 x 40mm D section	Dimensions (mm)			Bar Config	Pipe Centres	Element Wattage	ΔT 50°C Watts/BTUs		ΔT 60°C BTUs		£ ex VAT Chrome	£ inc VAT Chrome	£ ex VAT White	£ inc VAT White	Stock Info
	H	W	D				Chrome	White	Chrome	White					
MD001	800	305	80-100	3-5-6	255	100	177 / 604	271 / 925	763	1169	191.00	229.20	103.00	123.60	✓
MD001	800	405	80-100	3-5-6	355	125	226 / 771	346 / 1181	975	1492	196.00	235.20	109.00	130.80	✓
MD001	800	505	80-100	3-5-6	455	150	275 / 938	420 / 1433	1186	1811	216.00	259.20	122.00	146.40	✓
MD001	800	605	80-100	3-5-6	555	200	324 / 1105	495 / 1689	1397	2135	238.00	285.60	128.00	153.60	✓
MD001	1000	505	80-100	4-5-9	455	200	351 / 1198	446 / 1522	1514	1923	250.00	300.00	132.00	158.40	✓
MD001	1000	605	80-100	4-5-9	555	200	414 / 1413	510 / 1740	1785	2200	258.00	309.60	134.00	160.80	✓
MD001	1200	305	80-100	4-5-13	255	200	273 / 931	424 / 1447	1177	1829	270.00	324.00	136.00	163.20	✓
MD001	1200	405	80-100	4-5-13	355	200	350 / 1194	543 / 1853	1509	2342	276.00	331.20	147.00	176.40	✓
MD001	1200	505	80-100	4-5-13	455	300	428 / 1460	663 / 2262	1846	2859	301.00	361.20	164.00	196.80	✓
MD001	1200	605	80-100	4-5-13	555	400	505 / 1723	783 / 2672	2178	3377	333.00	399.60	177.00	212.40	✓
MD001	1500	505	80-100	4-5-7-12	455	300	534 / 1822	820 / 2798	2303	3536	379.00	454.80	189.00	226.80	✓
MD001	1500	605	80-100	4-5-7-12	555	400	631 / 2153	969 / 3306	2721	4192	424.00	508.80	196.00	235.20	✓
MD001	1800	405	80-100	4-5-12-13	355	400	521 / 1778	793 / 2706	2247	3420	433.00	519.60	210.00	252.00	✓
MD001	1800	505	80-100	4-5-12-13	455	600	638 / 2177	969 / 3306	2752	4179	467.00	560.40	219.00	262.80	✓
MD001	1800	605	80-100	4-5-12-13	555	600	754 / 2573	1146 / 3910	3252	4942	522.00	626.40	247.00	296.40	✓

# CHORUS 25MM WALL MOUNTED MD002

The curved version of the Focus. The Chorus has all the same attributes with high heat output and superb looks. Adjustable brackets through the crossbars also offer freedom and ease of installation. Prices shown are for Chrome or White central heating models.

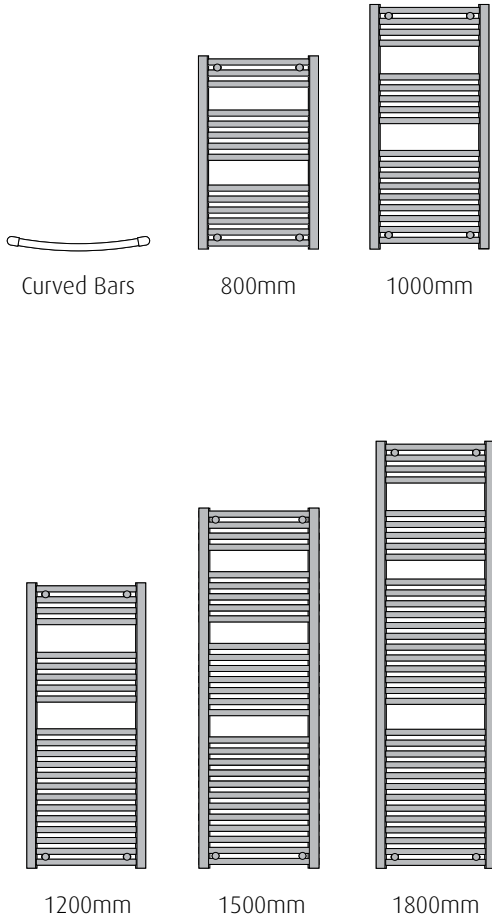

MS C E D 15



For valves and electric elements please see the Additions section.

Capped off ends with a hidden air vent create a smooth and modern finish on this towel warmer.



## CHORUS CURVED

Tube Ø 25 + 30 x 40mm D section	Dimensions (mm)			Bar Config	Pipe Centres	Element Wattage	ΔT 50°C Watts/BTUs		ΔT 60°C BTUs		£ ex VAT	£ inc VAT	£ ex VAT	£ inc VAT	Stock Info
	H	W	D				Chrome	White	Chrome	White	Chrome	Chrome	White	White	
MD002	800	505	98	3-5-6	455	150	275 / 938	420 / 1433	1186	1811	221.00	265.20	128.00	153.60	✓
MD002	800	605	103	3-5-6	555	200	324 / 1105	495 / 1689	1397	2135	251.00	301.20	136.00	163.20	✓
MD002	1000	505	98	4-5-9	455	200	351 / 1198	N/A	1514	N/A	270.00	324.00	N/A	N/A	✓
MD002	1000	605	103	4-5-9	555	200	414 / 1413	N/A	1785	N/A	276.00	331.20	N/A	N/A	✓
MD002	1200	505	98	4-5-13	455	300	428 / 1460	663 / 2262	1846	2859	320.00	384.00	174.00	208.80	✓
MD002	1200	605	103	4-5-13	555	400	505 / 1723	783 / 2672	2178	3377	348.00	417.60	187.00	224.40	✓
MD002	1500	505	98	4-5-7-12	455	300	534 / 1822	820 / 2798	2303	3536	440.00	528.00	206.00	247.20	✓
MD002	1500	605	103	4-5-7-12	555	400	631 / 2153	969 / 3306	2721	4179	495.00	594.00	216.00	259.20	✓
MD002	1800	505	98	4-5-12-13	455	600	638 / 2177	969 / 3306	2752	4179	496.00	595.20	238.00	285.60	✓
MD002	1800	605	103	4-5-12-13	555	600	754 / 2573	1146 / 3910	3252	4942	551.00	661.20	256.00	307.20	✓

# FOCUS COLOURS 25MM WALL MOUNTED MD001

Contemporary painted finishes in our popular 25mm horizontal tube multi-rail. Prices shown are for central heating models. Optional valves are available in complementary finishes. \*Mocha and Latte towel warmers are priced separately to the other colour choices.



For valves and electric elements please see the Additions section - VL003 pictured.



## FOCUS COLOURS \* Please note Mocha/Latte depth dimension is 85-100mm

Tube Ø 25 + 30 x 40mm D section	Dimensions (mm)			Bar Config	Pipe Centres	Element Wattage	ΔT 50°C Watts/BTUs	ΔT 60°C BTUs	£ ex VAT	£ inc VAT	£ ex VAT Colours	£ inc VAT Colours	Stock Info
	H	W	D										
MD001	800	405	74-84	3-5-6	355	125	346 / 1181	1493	183.00	219.60	130.00	156.00	✓
MD001	800	505	74-84	3-5-6	455	150	420 / 1433	1811	219.00	262.80	156.00	187.20	✓
MD001	1200	305	74-84	4-5-13	255	200	424 / 1447	1829	244.00	292.80	173.00	207.60	✓
MD001	1200	505	74-84	4-5-13	455	300	663 / 2262	2859	295.00	354.00	209.00	250.80	✓
MD001	1200	605	74-84	4-5-13	555	400	783 / 2672	3377	318.00	381.60	226.00	271.20	✓
MD001	1500	505	74-84	4-5-7-12	455	300	820 / 2798	3537	355.00	426.00	252.00	302.40	✓
MD001	1800	505	74-84	4-5-12-13	455	600	969 / 3306	4179	394.00	472.80	280.00	336.00	✓

# FOCUS METALLICS 25MM WALL MOUNTED MD001

Focus Brushed Brass, Focus Brushed Bronze, Focus Satin Brushed Nickel and Focus Gunmetal metallic finishes; in our quintessential 25mm horizontal tube multi-rail. Specially selected to compliment the latest interior design styles within three popular heights.

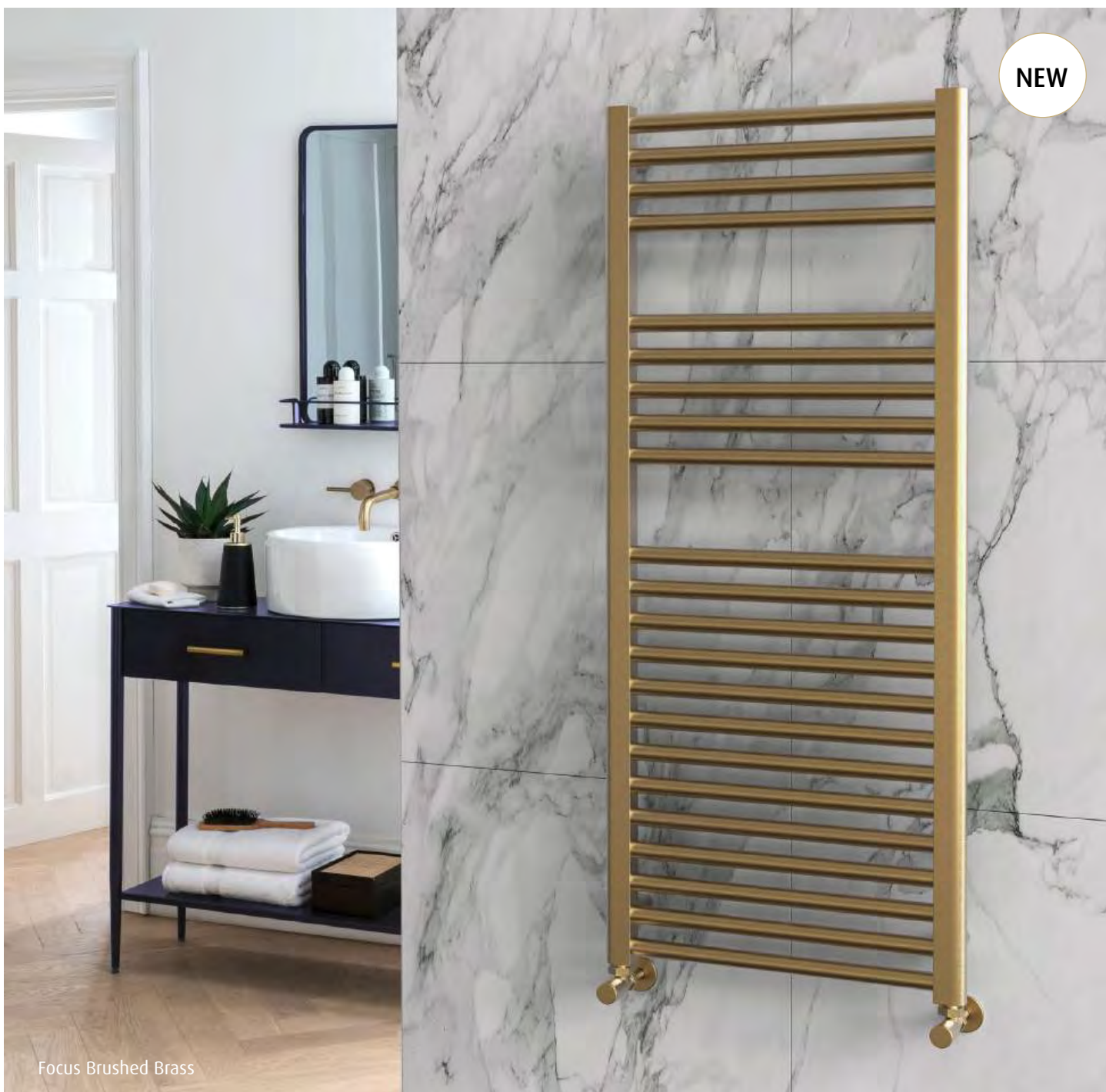

Focus Brushed Brass

MS C E D 15

For valves and electric elements please see the Additions section - VL033 pictured.



## FOCUS METALLICS

Tube Ø 25 + 30 x 40mm D section	Dimensions (mm)			Bar Config	Pipe Centres	Element Wattage	ΔT 50°C Watts/BTUs	ΔT 60°C BTUs	£ ex VAT Heating Only	£ inc VAT Heating Only	£ ex VAT Dual Fuel	£ inc VAT Dual Fuel	£ ex VAT Electric	£ inc VAT Electric	Stock Info
	H	W	D												
MD001-Metallics	800	500	76-88	3-5-6	455	150	275 / 938	1186	214.00	256.80	352.00	422.40	415.00	498.00	✓
MD001-Metallics	1200	500	76-88	4-5-13	455	300	428 / 1460	1846	310.00	372.00	448.00	537.60	511.00	613.20	✓
MD001-Metallics	1800	500	76-88	4-5-12-13	455	600	638 / 2177	2752	454.00	544.80	592.00	710.40	655.00	786.00	✓

# FOCUS HORIZONTAL 25MM WALL MOUNTED MD001H

Our Focus horizontal allows you to hang towels side by side and is a perfect fit for underneath a window or shelf, with high heat output and superb looks. Prices shown are for chrome, White or Anthracite central heating models. Please see page 146 for colour options.



Please note painted models are supplied with chrome brackets



For valves and electric elements please see the Additions section - VL003 pictured.

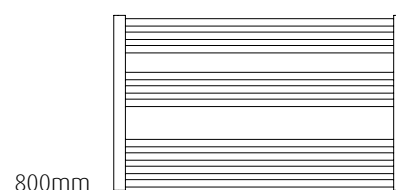
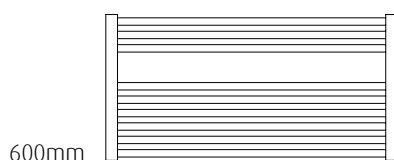
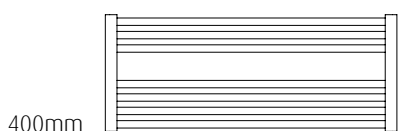

## FOCUS HORIZONTAL

Tube Ø 25 + 30 x 40mm D section	Dimensions (mm)			Bar Config	Pipe Centres	Element Wattage	ΔT 50°C Watts/BTUs		ΔT 60°C BTUs		£ ex VAT		£ inc VAT		Stock Info
	H	W	D				Chrome	Painted	Chrome	Painted	Chrome	Chrome	Anthracite/White	Anthracite/White	
MD001H	400	1000	85-100	3-4	955	100	200 / 682	302 / 1030	863	1302	149.00	178.80	106.00	127.20	✓
MD001H	500	1000	85-100	3-6	955	125	256 / 873	386 / 1317	1104	1665	171.00	205.20	123.00	147.60	✓
MD001H	600	1000	85-100	3-3-4	955	150	288 / 983	434 / 1481	1242	1872	182.00	218.40	138.00	165.60	✓

# STUDIO MD006

Simple style, with bold straight cross rails and discreet fixed brackets and a hidden rear air vent. Manufactured from high quality brass in an un-lacquered brushed brass finish as standard.

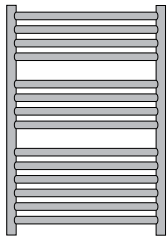

720mm

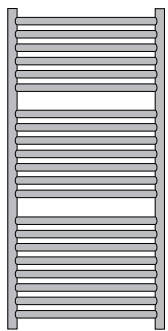

1000mm

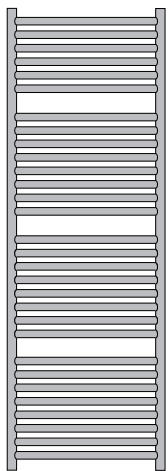

1435mm



For valves and electric elements please see the Additions section - VL003 pictured.



A lacquered finish can be provided with a supplement charge of 20% on the price of un-lacquered or chrome. Other bespoke metallic finishes are available at an additional cost, please see page 145.

## STUDIO

Tube Ø 31.8 + 25.4mm	Dimensions (mm)			Bar Config	Pipe Centres	Element Wattage	ΔT 50°C Watts/BTUs	ΔT 60°C BTUs	£ ex VAT Chrome or Brushed Brass	£ inc VAT Chrome or Brushed Brass	Stock Info
	H	W	D								
MD006	720	500	90	4-4-6	468	125	327 / 1116	1410	938.00	1125.60	
MD006	1000	500	90	6-7-8	468	200	482 / 1645	2079	1296.00	1555.20	
MD006	1435	500	90	6-8-8-8	468	300	690 / 2354	2976	1767.00	2120.40	

# CHUBE STAINLESS STEEL MD035

The round tube polished Stainless Steel design with rear air vent, brings together aesthetics and practicality. It will suit any modern bathroom. Please see page 146 for colour options. Stainless Steel suitable for all hot water systems.

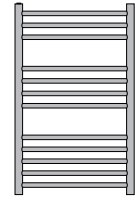

800mm

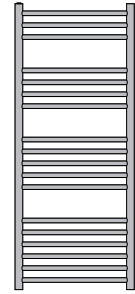

1200mm

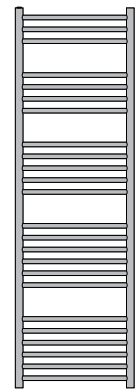

1600mm



For valves and electric elements please see the Additions section - VL003 pictured.



## CHUBE

Tube Ø 31.8 + 22mm

	Dimensions (mm)			Bar Config	Pipe Centres	Element Wattage	ΔT 50°C Watts/BTUs	ΔT 60°C BTUs	£ ex VAT Polished SS	£ inc VAT Polished SS	Stock Info
	H	W	D								
MD035	800	300	100	3-4-5	268	100	161 / 549	694	330.00	396.00	✓
MD035	800	400	100	3-4-5	368	100	197 / 672	850	362.00	434.40	✓
MD035	800	500	100	3-4-5	468	125	243 / 829	1048	394.00	472.80	✓
MD035	800	600	100	3-4-5	568	150	269 / 918	1160	455.00	546.00	✓
MD035	1200	300	100	3-4-5-6	268	125	240 / 819	1035	488.00	585.60	✓
MD035	1200	400	100	3-4-5-6	368	150	294 / 1003	1268	524.00	628.80	✓
MD035	1200	500	100	3-4-5-6	468	200	348 / 1187	1501	567.00	680.40	✓
MD035	1200	600	100	3-4-5-6	568	200	402 / 1372	1734	662.00	794.40	✓
MD035	1600	300	100	3-4-5-6-6	268	200	321 / 1095	1384	711.00	853.20	✓
MD035	1600	400	100	3-4-5-6-6	368	200	391 / 1334	1686	800.00	960.00	✓
MD035	1600	500	100	3-4-5-6-6	468	300	464 / 1583	2001	873.00	1047.60	✓
MD035	1600	600	100	3-4-5-6-6	568	300	536 / 1829	2312	961.00	1153.20	✓

# KERVE STAINLESS STEEL MD036

Kerve is the curvaceous sibling of the Chube. The design has an integral rear air vent for aesthetic appeal and ease of installation. Available in a wide range of heights and widths. Please see page 146 for colour options. Stainless Steel suitable for all hot water systems.

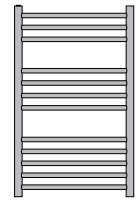

800mm

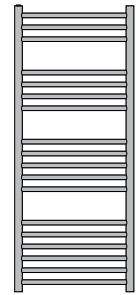

1200mm

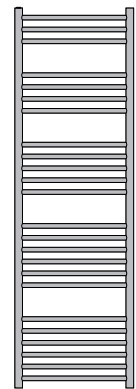

1600mm



Curved Bars



For valves and electric elements please see the Additions section - VL003 pictured.



## KERVE

Tube Ø 31.8 + 22mm	Dimensions (mm)			Bar Config	Pipe Centres	Element Wattage	ΔT 50°C Watts/BTUs	ΔT 60°C BTUs	£ ex VAT Polished SS	£ inc VAT Polished SS	Stock Info
	H	W	D								
MD036	800	500	120	3-4-5	468	125	243 / 829	1048	457.00	548.40	✓
MD036	800	600	130	3-4-5	568	150	269 / 918	1160	520.00	624.00	✓
MD036	1200	500	120	3-4-5-6	468	200	348 / 1187	1501	640.00	768.00	✓
MD036	1200	600	130	3-4-5-6	568	200	402 / 1372	1734	735.00	882.00	✓
MD036	1600	500	120	3-4-5-6-6	468	300	464 / 1583	2001	891.00	1069.20	✓
MD036	1600	600	130	3-4-5-6-6	568	300	536 / 1829	2312	977.00	1172.40	✓

# PEARL STAINLESS STEEL MD058

High quality polished Stainless Steel. Pearl's chic styling and sensible design allows you to hang towels side by side. Suitable for all hot water systems. Other colour finishes are available please see page 146.

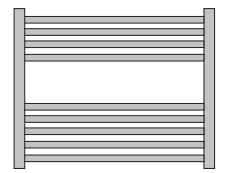

600mm 9 Bar

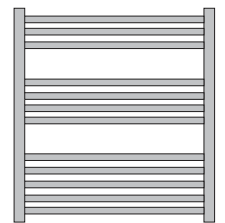

800mm 12 Bar



For valves and electric elements please see the Additions section - VL003 pictured.



## PEARL

	Dimensions (mm)			Bar Config	Pipe Centres	Element Wattage	$\Delta T$ 50°C Watts/BTUs	$\Delta T$ 60°C BTUs	£ ex VAT Polished	£ inc VAT Polished	Stock Info
	H	W	D								
MD058	600	750	100	4-5	718	100	419 / 1430	1807	498.00	597.60	✓
MD058	600	1000	100	4-5	968	125	517 / 1764	2230	574.00	688.80	✓
MD058	800	750	100	3-4-5	718	125	529 / 1805	2281	605.00	726.00	✓
MD058	800	1000	100	3-4-5	968	150	682 / 2327	2941	662.00	794.40	✓

# GALAXY STAINLESS STEEL MD059

Galaxy has clean lines and plenty of hanging space. Manufactured from polished Stainless Steel. Suitable for all hot water systems. Other colour finishes are available please see page 146.

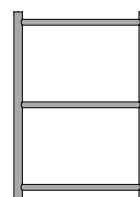

700mm

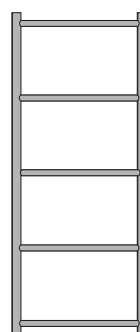

1200mm



1600mm



For valves and electric elements please see the Additions section - VL003 pictured.



## GALAXY

Tube Ø 31.8 + 22mm

	Dimensions (mm)			Bar Config	Pipe Centres	Element Wattage	ΔT 50°C Watts/BTUs	ΔT 60°C BTUs	£ ex VAT Polished	£ inc VAT Polished	Stock Info
	H	W	D								
MD059	700	500	100	3	468	75	86 / 293	371	354.00	424.80	✓
MD059	1200	500	100	5	468	100	217 / 740	936	548.00	657.60	✓
MD059	1600	500	100	7	468	125	296 / 1010	1277	704.00	844.80	✓

# TUNE MD003

Tune has straight cross rails and the Melody has a gentle curve. Both formats are exceptionally practical and work well in bathrooms and kitchens alike. Prices shown are Chrome finished for central heating models.



Blanking Plug with Aroma  
Oil Dish AC035  
£12.00 ex VAT, £14.40 inc VAT

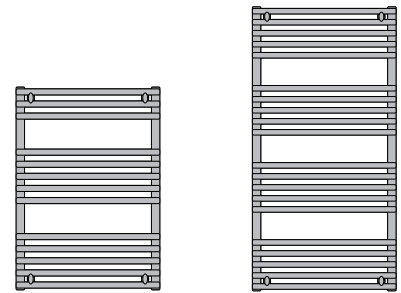

772mm

1186mm

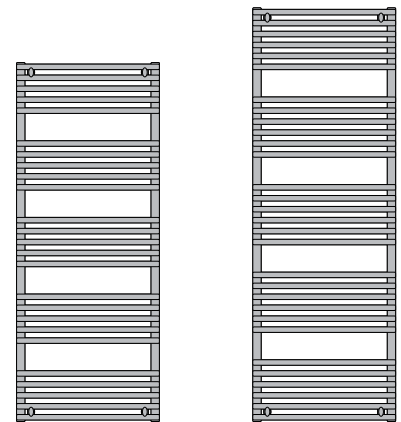

1508mm

1738mm



For valves and electric elements please see the Additions section - VL003 pictured.



## TUNE

Tube Ø 32 + 22mm	Dimensions (mm)			Bar Config	Pipe Centres	Element Wattage	ΔT 50°C Watts/BTUs	ΔT 60°C BTUs	£ ex VAT Chrome	£ inc VAT Chrome	Stock Info
	H	W	D								
MD003	772	500	80 - 95	3-5-5	450	125	290 / 989	1251	237.00	284.40	✓
MD003	772	600	80 - 95	3-5-5	550	200	347 / 1184	1251	251.00	301.20	✓
MD003	1186	500	80 - 95	5-5-5-5	450	300	465 / 1587	2005	321.00	385.20	✓
MD003	1186	600	80 - 95	5-5-5-5	550	300	553 / 1887	2385	349.00	418.80	✓
MD003	1508	500	80 - 95	5-5-5-5-5	450	400	581 / 1982	2506	385.00	462.00	✓
MD003	1508	600	80 - 95	5-5-5-5-5	550	400	686 / 2341	2959	418.00	501.60	✓
MD003	1738	500	80 - 95	6-6-6-6-6	450	600	687 / 2344	2959	443.00	531.60	✓
MD003	1738	600	80 - 95	6-6-6-6-6	550	600	815 / 2781	3515	480.00	576.00	✓

# MELODY MD004

Our curved model of Tune - MD003, the MD004's tube on tube details produce a clean, modern and smooth look. Using the iconic form of the multi-rail alongside the extra detailed touches creates an alternative look for any setting.



For valves and electric elements please see the Additions section - VL003 pictured.



## MELODY

Tube Ø 32 + 22mm

	Dimensions (mm)			Bar Config	Pipe Centres	Element Wattage	ΔT 50°C Watts/BTUs	ΔT 60°C BTUs	£ ex VAT Chrome	£ inc VAT Chrome	Stock Info
	H	W	D								
MD004	772	500	100 - 115	3-5-5	450	125	290 / 989	1251	241.00	289.20	✓
MD004	772	600	100 - 115	3-5-5	550	200	347 / 1184	1251	259.00	310.80	✓
MD004	1186	500	100 - 115	5-5-5-5	450	300	465 / 1587	2005	325.00	390.00	✓
MD004	1186	600	100 - 115	5-5-5-5	550	300	553 / 1887	2385	380.00	456.00	✓
MD004	1508	500	100 - 115	5-5-5-5-5	450	400	581 / 1982	2506	394.00	472.80	✓
MD004	1508	600	100 - 115	5-5-5-5-5	550	400	686 / 2341	2959	428.00	513.60	✓
MD004	1738	500	100 - 115	6-6-6-6-6	450	600	687 / 2344	2959	449.00	538.80	✓
MD004	1738	600	100 - 115	6-6-6-6-6	550	600	815 / 2781	3515	489.00	586.80	✓





VOGUE UK

EST | 1990

## TRADITIONAL

Go timeless and give your room a focal point that never fails to impress.

Our range of classic designs, in a stunning choice of colours and finishes, add instant elegance to your room, each is crafted to stand the test of time.

Classic products are now creating new traditions. Interior Designers are incorporating handmade products and blending simple schemes with timeless classical notes. Materials such as solid brass, have an integrity that is clear to see when used as an accent within modern design.

Many Vogue UK traditional products are known internationally for being part of a genre within bathroom interiors. These bold designs encapsulate Britishness with history, culture, design and time honoured craftsmanship.

# REGENCY FLOOR & WALL MOUNTED LG004-MS

The classic column radiator towel rail, offering high heat output with Legacy ball joints. Mild Steel manufactured, Chrome finished framework with an integral white mild steel column radiator. Colour options only apply to the inset radiator, not the frame. Other bespoke metallic frame finishes are available at an additional cost, please see page 145 & 146.



For valves and electric elements please see the Additions section - VL008 pictured.



**MILD STEEL**  
SUPPLEMENTS £ = Chrome + >

Gold Pricing POA



Bright Nickel:



+ £221.00 ex VAT  
+ £265.20 inc VAT

Brushed Nickel:



+ £309.00 ex VAT  
+ £370.80 inc VAT

## REGENCY-MS

Tube Ø 31.8	Dimensions (mm)			Sections	Face to Face Connections	Element Wattage	ΔT 50°C Watts/BTUs	ΔT 60°C BTUs	£ ex VAT Chrome	£ inc VAT Chrome	Stock Info
	H	W	D								
LG004-MS	963	538	230	5	393	200	392 / 1338	1691	566.00	679.20	✓
LG004-MS	963	673	230	8	528	300	554 / 1890	2389	671.00	805.20	✓
LG004-MS	963	763	230	10	618	400	554 / 1890	2816	766.00	919.20	✓

# REGENCY FLOOR & WALL MOUNTED LG004-BR / OG006-BR

An authentic column radiator towel rail, offering high heat output. Choose from our Originals or Legacy ball joints. Brass manufactured, Chrome finished framework with an integral White Mild Steel column radiator. Bespoke finishes and radiator colours are available at an additional cost, please see page 145 & 146.



For valves and electric elements please see the Additions section - VL008 pictured.

BR C E D 30



LG

OG

Ball joint detail options:

Legacy simple ball joint - **LG** code or Originals double fluted ball joint - **OG** code

## REGENCY-BR

Tube Ø 31.8

	Dimensions (mm)			Sections	Face to Face Connections	Element Wattage	ΔT 50°C Watts/BTUs	ΔT 60°C BTUs	£ ex VAT Chrome	£ inc VAT Chrome	Stock Info
	H	W	D								
LG004C-BR	938	500	250	5	343	200	392 / 1338	1691	1271.00	1525.20	
LG004B-BR	938	675	250	8	518	400	554 / 1890	2389	1284.00	1540.80	
LG004A-BR	938	735	250	10	578	400	653 / 2228	2816	1293.00	1551.60	
OG006C-BR	938	500	250	5	343	200	392 / 1338	1691	1300.00	1560.00	
OG006B-BR	938	675	250	8	518	400	554 / 1890	2389	1310.00	1572.00	
OG006A-BR	938	735	250	10	578	400	653 / 2228	2816	1323.00	1587.60	

# REGENCY WALL MOUNTED LG005 / OG015

This towel rail looks great alongside the bath, at the right height for reaching your luxuriously warm towel. Brass or Mild Steel manufactured framework with an integral White Mild Steel column radiator. Choose from our Originals or Legacy ball joints. Bespoke finishes are available at an additional cost, please see page 145 & 146.



Ball joint detail options for brass models:  
 Legacy simple ball joint - **LG** code  
 Originals double fluted ball joint - **OG** code



## REGENCY-MS

Tube Ø 31.8



	Dimensions (mm)			Sections	Pipe Centres	Element Wattage	ΔT 50°C Watts/BTUs	ΔT 60°C BTUs	£ ex VAT Chrome	£ inc VAT Chrome	Stock Info
	H	W	D								
LG005-MS	740	675	250	8	600	300	568 / 1938	2450	666.00	799.20	✓

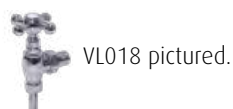

**MILD STEEL SUPPLEMENTS** £ = Chrome + >

Gold Pricing POA



Bright Nickel:

+ £221.00 ex VAT  
+ £265.20 inc VAT



Brushed Nickel:

+ £309.00 ex VAT  
+ £370.80 inc VAT



## REGENCY-BR

Tube Ø 31.8



	Dimensions (mm)			Sections	Pipe Centres	Element Wattage	ΔT 50°C Watts/BTUs	ΔT 60°C BTUs	£ ex VAT Chrome	£ inc VAT Chrome	Stock Info
	H	W	D								
LG005C-BR	740	500	250	5	425	200	384 / 1310	1656	1330.00	1596.00	👇
LG005B-BR	740	675	250	8	600	400	541 / 1846	2333	1420.00	1704.00	👇
LG005A-BR	740	735	250	10	660	400	643 / 2194	2773	1481.00	1777.20	👇
OG015-BR	740	500	250	5	425	200	384 / 1310	1656	1361.00	1633.20	👇
OG015-BR	740	675	250	8	600	400	541 / 1846	2333	1443.00	1731.60	👇
OG015-BR	740	735	250	10	660	400	643 / 2194	2773	1463.00	1755.60	👇

# REGENCY II WALL MOUNTED LG036 / OG009

This handmade British design will stand the test of time. A Vogue UK design, liked for its heat output, hanging space and unique design. Choose from our Originals or Legacy ball joints. Brass manufactured, Chrome finished framework with an integral White Mild Steel column radiator. Bespoke finishes and radiator colours are available at an additional cost, please see page 145 & 146.



For valves and electric elements please see the Additions section - VL008 pictured.



## REGENCY II

Tube Ø 31.8

Ball joint detail options:

Legacy simple ball joint - **LG** code or Originals double fluted ball joint - **OG** code

	Dimensions (mm)			Sections	Pipe Centres	Element Wattage	$\Delta T$ 50°C Watts/BTUs	$\Delta T$ 60°C BTUs	£ ex VAT Chrome	£ inc VAT Chrome	Stock Info
	H	W	D								
LG036-BR	825	500	150	5	425	200	384 / 1310	1656	1328.00	1593.60	👇
LG036-BR	825	675	150	8	600	400	570 / 1945	2458	1419.00	1702.80	👇
LG036-BR	825	735	150	10	660	400	671 / 2289	2894	1480.00	1776.00	👇
OG009C-BR	825	500	160	5	425	200	384 / 1310	1656	1410.00	1692.00	👇
OG009C-BR	825	675	160	8	600	400	570 / 1945	2458	1493.00	1791.60	👇
OG009A-BR	825	735	160	10	660	400	671 / 2289	2894	1546.00	1855.20	👇

# REGENCY TALL FLOOR OR WALL MOUNTED LG013-MS

Ideal for family bathrooms or a special en-suite. Mild Steel manufactured framework with an integral White Mild Steel column radiator. Prices shown are Chrome finished for central heating models.



## MILD STEEL SUPPLEMENTS

£ = Chrome + >



Gold Pricing POA



Bright Nickel:  
+ £221.00 ex VAT  
+ £265.20 inc VAT



Brushed Nickel:  
+ £309.00 ex VAT  
+ £370.80 inc VAT

Floor & Wall Mounted Option



VL008 pictured.



## REGENCY TALL WALL MOUNTED-MS

Tube Ø 31.8	Dimensions (mm)			Sections	Pipe Centres	Element Wattage	ΔT 50°C Watts/BTUs	ΔT 60°C BTUs	£ ex VAT Chrome	£ inc VAT Chrome	Stock Info
	H	W	D								
LG013WM-MS	1403	575	250	5	500	400	824 / 2811	3554	808.00	969.60	✓

## REGENCY TALL FLOOR & WALL MOUNTED-MS

Tube Ø 31.8	Dimensions (mm)			Sections	Face to Face Connections	Element Wattage	ΔT 50°C Watts/BTUs	ΔT 60°C BTUs	£ ex VAT Chrome	£ inc VAT Chrome	Stock Info
	H	W	D								
LG013FW-MS	1500	500	250	5	343	400	815 / 2781	3515	898.00	1077.60	✓

# REGENCY TALL FLOOR & WALL MOUNTED LG013-BR / OG007-BR

Brass manufactured with an integral White Mild Steel column radiator, Regency Tall provides the luxury of a superior finish. Choose from our Originals or Legacy ball joints. Bespoke finishes are available at an additional cost, please see page 145.



For valves and electric elements please see the Additions section - VL008 pictured.



## REGENCY TALL FLOOR & WALL MOUNTED-BR

Tube Ø 31.8	Dimensions (mm)			Sections	Face to Face Connections	Element Wattage	ΔT 50°C Watts/BTUs	ΔT 60°C BTUs	£ ex VAT Chrome	£ inc VAT Chrome	Stock Info
	H	W	D								
LG013FW-BR	1500	500	250	5	343	400	738 / 2518	3183	1548.00	1857.60	👇
OG007FW-BR	1500	500	250	5	343	400	738 / 2518	3183	1753.00	2103.60	👇

# ARCADIA FLOOR MOUNTED LG017/ OG017

Arcadia, the classic war horse. A very British design which has stood the test of time. Choose from Originals or Legacy ball joints. Brass or Mild Steel manufactured models, Chrome finished as standard. Mild Steel models are fitted with the Legacy ball joint as standard. Bespoke finishes are available at an additional cost, please see page 145.



Ball joint detail options for brass models:  
 Legacy simple ball joint - **LG** code  
 Originals double fluted ball joint - **OG** code



## ARCADIA - MS



Tube Ø 31.8	Dimensions (mm)			Bar Config	Face to Face Connections	Element Wattage	ΔT 50°C Watts/BTUs	ΔT 60°C BTUs	£ ex VAT Chrome	£ inc VAT Chrome	Stock Info
	H	W	D								
LG017-MS	850	598	233	7	453	2 x 100	439 / 1498	1893	849.00	1018.80	✓



VL008 pictured.

**MILD STEEL SUPPLEMENTS** £ = Chrome + >

Gold Pricing POA



Bright Nickel:

+ £221.00 ex VAT  
+ £265.20 inc VAT



Brushed Nickel:

+ £309.00 ex VAT  
+ £370.80 inc VAT



## ARCADIA - BR



Tube Ø 31.8	Dimensions (mm)			Bar Config	Face to Face Connections	Element Wattage	ΔT 50°C Watts/BTUs	ΔT 60°C BTUs	£ ex VAT Chrome	£ inc VAT Chrome	Stock Info
	H	W	D								
LG017-BR	850	600	235	7	443	2 x 100	439 / 1498	1893	1525.00	1830.00	👤
OG017-BR	850	600	275	7	443	2 x 100	439 / 1498	1893	1870.00	2244.00	👤

# BAROQUE FLOOR MOUNTED LG014/ OG014

Inspired by yesteryear. The Baroque uses a classical White Mild Steel column radiator within a handcrafted, Chrome Plated, Brass framework. Superior heat output and towel hanging space are abundant in this imposing feature design. Choose from Originals or Legacy ball joints. Bespoke finishes are available at an additional cost, please see page 145.



For valves and electric elements please see the Additions section - VL008 pictured.



Ball joint detail options:

Legacy simple ball joint - **LG** code or Originals double fluted ball joint - **OG** code



## BAROQUE

Tube Ø 31.8

	Dimensions (mm)			Sections	Face to Face Connections	Element Wattage	ΔT 50°C Watts/BTU's	ΔT 60°C BTU's	£ EX Chrome	£ INC Chrome	Stock Info
	H	W	D								
LG014-BR	900	675	325	8	518	200 + 300	871 / 2972	3756	1998.00	2397.60	
OG016-BR	900	675	350	8	518	200 + 300	871 / 2972	3756	2162.00	2594.40	

# BALLERINA WALL MOUNTED LG025 / LG010 / LG021 / OG002

High quality Brass, durable for longevity, the Ballerina is available with your choice of Legacy (as illustrated) or Originals ball joint. Prices shown are Chrome finished all heating and hot water systems. Bespoke finishes are available at an additional cost, please see page 145 for other finishes. 6 bar models are also available to order as bespoke.



LG021C 5 Bars



LG021B 4 Bars



LG025A 3 Bars

Ball joint detail options for brass models:  
Legacy simple ball joint - **LG** code  
Originals double fluted ball joint - **OG** code



For valves and electric elements please see the Additions section - VL018 pictured.



## BALLERINA-BR

Tube Ø 31.8mm	Dimensions (mm)			Bar Config	Pipe Centres	Element Wattage	ΔT 50°C Watts/BTU's	ΔT 60°C BTU's	£ ex VAT Chrome	£ INC Chrome	Stock Info
	H	W	D								
LG025A-BR	675	675	125	3	600	100	167 / 570	720	912.00	1094.40	↓
LG025B-BR	675	825	125	3	750	125	190 / 648	819	931.00	1117.20	↓
LG010A-BR	750	500	125	4	425	100	169 / 577	729	1006.00	1207.20	↓
LG021B-BR	1275	525	125	4	450	125	239 / 815	1031	1129.00	1354.80	↓
LG021F-BR	1275	675	125	4	600	150	266 / 908	1147	1150.00	1380.00	↓
LG021C-BR	1575	525	125	5	450	125	292 / 996	1259	1350.00	1620.00	↓
LG021G-BR	1575	675	125	5	600	150	327 / 1116	1410	1374.00	1648.80	↓
OG002B-BR	675	675	135	3	600	100	167 / 570	720	1022.00	1226.40	↓
OG002C-BR	675	825	135	3	750	125	190 / 648	819	1053.00	1263.60	↓
OG002D-BR	750	525	135	4	450	100	169 / 577	729	1235.00	1482.00	↓
OG002A-BR	1275	525	135	4	450	125	239 / 815	1031	1242.00	1490.40	↓
OG002E-BR	1275	675	135	4	600	150	266 / 908	1147	1253.00	1503.60	↓
OG002F-BR	1575	525	135	5	450	125	292 / 996	1259	1502.00	1802.40	↓
OG002G-BR	1575	675	135	5	600	150	327 / 1116	1410	1512.00	1814.40	↓

# BALLERINA WALL & FLOOR MOUNTED LG021 / LG024 / OG003

High quality Brass, supremely durable for longevity. The Ballerina wall and floor is available with your choice of Legacy (illustrated) or Originals ball joint. Prices shown are Chrome finished all heating and hot water systems. Bespoke finishes are available at an additional cost, please see page 145 for other finishes. 6 bar models are also available to order as bespoke.



LG021H 5 Bars



LG021E 4 Bars



LG024A 3 Bars

Ball joint detail options for brass models:

Legacy simple ball joint - **LG** code

Originals double fluted ball joint - **OG** code



**LG**



**OG**



For valves and electric elements please see the Additions section - VL018 pictured.



## BALLERINA-BR

Tube Ø 31.8mm	Dimensions (mm)			Bar Config	Face to Face Connections	Element Wattage	ΔT 50°C Watts/BTU's	ΔT 60°C BTU's	£ ex VAT Chrome	£ INC Chrome	Stock Info
	H	W	D								
LG024C-BR	938	575	138	3	418	100	163 / 556	703	961.00	1153.20	👤
LG024A-BR	938	675	138	3	518	125	195 / 665	841	983.00	1179.60	👤
LG024B-BR	938	825	138	3	668	150	207 / 706	893	1032.00	1238.40	👤
LG021A-BR	1238	525	138	4	368	125	239 / 815	1031	1216.00	1459.20	👤
LG021E-BR	1238	675	138	4	518	150	266 / 908	1147	1236.00	1483.20	👤
LG021D-BR	1538	525	138	5	368	150	292 / 996	1259	1260.00	1512.00	👤
LG021H-BR	1538	675	138	5	518	150	327 / 1116	1410	1356.00	1627.20	👤
OG003A-BR	938	575	138	3	418	100	163 / 556	703	1123.00	1347.60	👤
OG003B-BR	938	675	138	3	518	125	195 / 665	841	1133.00	1359.60	👤
OG003C-BR	938	825	138	3	668	150	207 / 706	893	1148.00	1377.60	👤
OG003D-BR	1238	525	138	4	368	125	239 / 815	1031	1318.00	1581.60	👤
OG003E-BR	1238	675	138	4	518	150	266 / 908	1147	1337.00	1604.40	👤
OG003F-BR	1538	525	138	5	368	125	292 / 996	1259	1490.00	1788.00	👤
OG003G-BR	1538	675	138	5	518	150	327 / 1116	1410	1512.00	1814.40	👤

# BALLERINA FLOOR AND WALL LG024A-MS / LG021-MS

This Ballerina wall and floor mounted towel rail is offered in a Mild Steel Legacy ball joint version as illustrated on this page. Prices shown are Chrome finished central heating models. Bespoke finishes are available at an additional cost, please see page 146 for other finishes. The LG021-MS comes with added ball joints on the inlet connections to complement the style further.



VL008 pictured.

**MILD STEEL SUPPLEMENTS** £ = Chrome + >

Gold Pricing POA



Bright Nickel:

+ £221.00 ex VAT  
+ £265.20 inc VAT



Brushed Nickel:

+ £309.00 ex VAT  
+ £370.80 inc VAT



## BALLERINA-MS

Tube Ø 31.8mm	Dimensions (mm)			Bar Config	Face to Face Connections	Element Wattage	ΔT 50°C Watts/BTU's	ΔT 60°C BTU's	£ ex VAT Chrome	£ INC Chrome	Stock Info
	H	W	D								
LG024A-MS	848	598	138	4	454	100	163 / 556	703	522.00	626.40	✓
LG021-MS	1549	598	138	5	454	150	310 / 1058	1337	582.00	698.40	✓

# BALLERINA WALL MOUNTED LG010A-MS (Chrome Finish)

The Ballerina wall mounted towel rail is offered in a Legacy ball joint Mild Steel version, as detailed on this page. A design classic, which will never date. Prices shown are Chrome finished central heating models. Bespoke finishes are available at an additional cost.

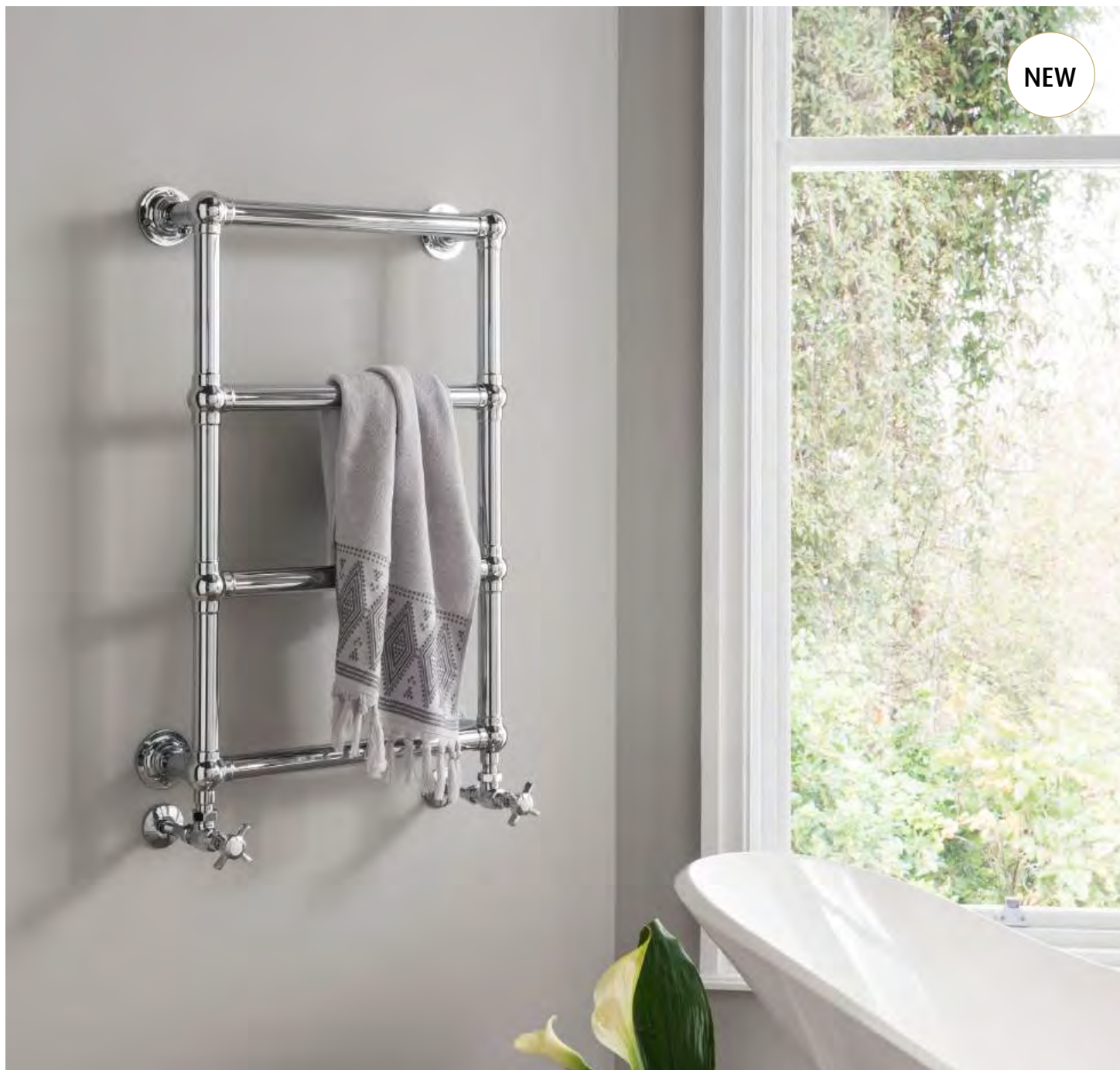

MS C E D 15



VL008 pictured.

**MILD STEEL SUPPLEMENTS** £ = Chrome + >

Gold Pricing POA



Bright Nickel:

+ £221.00 ex VAT  
+ £265.20 inc VAT



Brushed Nickel:

+ £309.00 ex VAT  
+ £370.80 inc VAT



## BALLERINA-MS

Tube Ø 31.8mm	Dimensions (mm)			Bar Config	Pipe Centres	Element Wattage	ΔT 50°C Watts/BTU's	ΔT 60°C BTU's	£ ex VAT Chrome	£ inc VAT Chrome	Stock Info
	H	W	D								
LG010A-MS	748	498	125	4	425	100	169 / 577	731	499.00	598.80	✓
LG010B-MS	1193	498	125	5	425	150	201 / 686	869	699.00	838.80	✓
LG010C-MS	1548	498	125	6	425	200	312 / 1063	1347	799.00	958.80	✓

# BALLERINA WALL MOUNTED LG010A-MS (Matt Black Finish)

The Matt Black finish of Ballerina takes a classic into modern era, sitting comfortably within contemporary bathrooms. The finish works well with matching matt black taps and showers, or as a contrast with dark furniture and coupled with brushed brass fittings. The three heights of this design offer ample hanging space for your requirements.



For valves and electric elements please see the Additions section - VL033 pictured.

MS C E D 15

## BALLERINA-MS MATT BLACK

Tube Ø 31.8mm	Dimensions (mm)			Bar Config	Pipe Centres	Element Wattage	ΔT 50°C Watts/BTU's	ΔT 60°C BTU's	£ ex VAT Matt Black	£ inc VAT Matt Black	Stock Info
	H	W	D								
LG010A-MS	748	498	125	4	425	100	186 / 635	805	449.00	538.80	✓
LG010B-MS	1193	498	125	5	425	150	321 / 1096	1389	629.00	754.80	✓
LG010C-MS	1548	498	125	6	425	200	394 / 1346	1705	709.00	850.80	✓

# BALLERINA WALL MOUNTED LG010A-MS (Focus Brushed Brass Finish)

The Ballerina wall mounted in a Brushed Brass offers the latest metallic finish as an update to this popular and very functional towel rail. This finish bridges both traditional and contemporary classic interior design. Simple matching valves and connection tubes with cover plates complete the look. See the additions section on page 142.



NEW



For valves and electric elements please see the Additions section - VL033 pictured.

MS C E D 15

## BALLERINA-MS FOCUS BRUSHED BRASS

Tube Ø 31.8mm	Dimensions (mm)			Bar Config	Pipe Centres	Element Wattage	ΔT 50°C Watts/BTU's	ΔT 60°C BTU's	£ ex VAT F-Brushed Brass	£ inc VAT F-Brushed Brass	Stock Info
	H	W	D								
LG010A-MS	748	498	130	4	425	100	171 / 584	740	549.00	658.80	✓
LG010B-MS	1193	498	130	5	425	150	269 / 916	1161	719.00	862.80	✓
LG010C-MS	1548	498	130	6	425	200	410 / 1399	1773	899.00	1078.80	✓

# GRANDEUR FLOOR & WALL MOUNTED GD032FW

Reflecting the quality and craftsmanship of a bygone age. Manufactured from our most robust larger sized brass tube and ball joints. This towel rail is timeless and sits well in any traditional setting. Brass manufactured with a Chrome finish as standard. Bespoke finishes are available at an additional cost, please see page 145 for other finishes.

Image showing Antique Copper finish.



For valves and electric elements please see the Additions section - VL008 pictured.



GD Grandeur larger ball joint with period nut detailing.



## GRANDEUR

Tube Ø 38.1mm	Dimensions (mm)			Bar Config	Face to Face Connections	Element Wattage	ΔT 50°C Watts/BTU's	ΔT 60°C BTU's	£ ex VAT Chrome	£ INC Chrome	Stock Info
	H	W	D								
GD032FW	943	686	163	3	522	125	243 / 829	1048	1834.00	2200.80	👇
GD032FW	1243	686	163	4	522	200	319 / 1088	1376	2294.00	2752.80	👇

# GRANDEUR WALL MOUNTED GD032WM

The wall mounted Grandeur provides ample warm towel hanging space. Classical looks and a robust traditional quality with larger sized brass tube and ball joints. Designed to outlive fashion. Brass manufactured with a Chrome finish as standard. Bespoke finishes are available at an additional cost, please see page 145 for other finishes.



For valves and electric elements please see the Additions section - VL008 pictured.



**GD** Grandeur larger ball joint with period nut detailing.



## GRANDEUR

Tube Ø 38.1mm	Dimensions (mm)			Bar Config	Pipe Centres	Element Wattage	ΔT 50°C Watts/BTU's	ΔT 60°C BTU's	£ ex VAT Chrome	£ INC Chrome	Stock Info
	H	W	D								
GD032WM	686	686	154	3	600	100	220 / 751	949	1928.00	2313.60	👇
GD032WM	1286	636	154	4	550	150	321 / 1095	1384	2347.00	2816.40	👇

# BUTLER FLOOR & WALL MOUNTED LG035 / OG004

This traditional design is tactile and sturdy, a centrepiece for a classically designed bathroom. Brass manufactured, shown with the Originals ball joint, Legacy ball joints are also available. Chrome finish as standard. Bespoke finishes are available at an additional cost, please see page 145 for other finishes.



Please note: The design will slightly alter if ordering lacquered brass or lacquered brushed brass.



For valves and electric elements please see the Additions section - VL008 pictured.



**LG** - Legacy Ball Joint



**OG** - Originals Ball Joint



## BUTLER

Tube Ø 31.8mm	Dimensions (mm)			Bar Config	Face to Face Connections	Element Wattage	ΔT 50°C Watts/BTU's	ΔT 60°C BTU's	£ ex VAT Chrome	£ INC Chrome	Stock Info
	H	W	D								
LG035	940	75	488	4	268	100	156 / 532	673	1026.00	1231.20	
OG004	965	75	488	4	268	100	156 / 532	673	1092.00	1310.40	

# HAMLET WALL MOUNTED LG037 / OG001

Small is always beautiful. The Hamlet is perfect for en suites and downstairs WCs where space is a premium, but warm dry towels are welcome. Choose from our Originals or Legacy ball joints. Chrome finish as standard. Bespoke finishes are available at an additional cost, please see page 145 for other finishes.



Image showing Antique Bronze finish.



For valves and electric elements please see the Additions section - VL008 pictured.



**LG** - Legacy Ball Joint



**OG** - Originals Ball Joint

BR H E D DL 30

## HAMLET

Tube Ø 31.8mm	Dimensions (mm)			Bar Config	Pipe Centres	Element Wattage	ΔT 50°C Watts/BTU's	ΔT 60°C BTU's	£ ex VAT Chrome	£ INC Chrome	Stock Info
	H	W	D								
LG037	235	575	125	2	500	50	79 / 270	341	683.00	819.60	
OG001	235	575	135	2	500	50	79 / 270	341	762.00	914.40	

# ELIZABETH FLOOR & WALL MOUNTED LG003 / OG019

With sculptured lines and quality Original or Legacy ball joints the Elizabeth has a twist on tradition. Choose from Brass or Mild Steel manufactured models, Chrome finished as standard. Bespoke finishes are available at an additional cost, please see page 145.



**LG** - Legacy Ball Joint



**OG** - Originals Ball Joint

## ELIZABETH - MS

Tube Ø 31.8 + 25 + 19mm

	Dimensions (mm)			Bar Config	Face to Face Connections	Element Wattage	ΔT 50°C Watts/BTU's	ΔT 60°C BTU's	£ ex VAT Chrome	£ inc VAT Chrome	Stock Info
	H	W	D								
LG003-MS	963	673	168	8	528	125	290 / 989	1251	519.00	622.80	✓



VL008 pictured.

**MILD STEEL SUPPLEMENTS** £ = Chrome + >

Gold Pricing POA



Bright Nickel:

+ £221.00 ex VAT  
+ £265.20 inc VAT



Brushed Nickel:

+ £309.00 ex VAT  
+ £370.80 inc VAT



## ELIZABETH - BR

Tube Ø 31.8 + 25 .4mm

	Dimensions (mm)			Bar Config	Face to Face Connections	Element Wattage	ΔT 50°C Watts/BTU's	ΔT 60°C BTU's	£ ex VAT Chrome	£ inc VAT Chrome	Stock Info
	H	W	D								
LG003A	938	675	138	7	518	150	290 / 989	1251	1197.00	1436.40	👤
LG003B	938	825	138	7	668	150	372 / 1269	1604	1235.00	1482.00	👤
OG019A	938	675	138	7	518	150	290 / 989	1251	1336.00	1603.20	👤
OG019B	938	825	138	7	668	150	372 / 1269	1604	1372.00	1646.40	👤



# ELIZABETH WALL MOUNTED LG003 / OG019

The wall mounted Elizabeth is available in two widths with your choice of Legacy (as illustrated) or Originals ball joints. Chrome finished as standard. Bespoke finishes are available at an additional cost, please see page 145.



For valves and electric elements please see the Additions section - VL008 pictured.



**LG** - Legacy Ball Joint



**OG** - Originals Ball Joint



## ELIZABETH WALL MOUNTED

Tube Ø 31.8 + 25.4mm	Dimensions (mm)			Bar Config	Pipe Centres	Element Wattage	ΔT 50°C Watts/BTU's	ΔT 60°C BTU's	£ ex VAT Chrome	£inc VAT Chrome	Stock Info
	H	W	D								
LG003D	740	675	125	7	600	125	290 / 989	1251	1226.00	1471.20	👤
LG003E	740	825	125	7	750	150	372 / 1269	1604	1266.00	1519.20	👤
OG019D	740	675	135	7	600	125	290 / 989	1251	1363.00	1635.60	👤
OG019E	740	825	135	7	750	150	372 / 1269	1604	1399.00	1678.80	👤

# ART MODERNE FLOOR & WALL MOUNTED OG011

Deco decadence in a nutshell. High quality hexagonal brass tube manufacture, crafted to a gleaming finish. Available in two sizes and chrome finish as standard. Bespoke finishes are available at an additional cost, please see page 145 for other finishes.



For valves and electric elements please see the Additions section - VL006 pictured.



Art Moderne  
Corner Joint Detail.



## ART MODERNE

Tube Ø 32mm HEX	Dimensions (mm)			Bar Config	Face to Face Connections	Element Wattage	ΔT 50°C Watts/BTU's	ΔT 60°C BTU's	£ ex VAT Chrome	£ inc VAT Chrome	Stock Info
	H	W	D								
OG011B	943	600	175	3	428	100	197 / 672	850	1164.00	1396.80	👤
OG011A	1543	550	168	5	378	125	318 / 1085	1371	1460.00	1752.00	👤

# ART MODERNE WALL MOUNTED OG010

The wall mounted Art Moderne is available in three different sizes to suit your room. Brass manufactured with a chrome finish as standard. Bespoke finishes are available at an additional cost, please see page 145 for other finishes.



For valves and electric elements please see the Additions section - VL006 pictured.



Art Moderne  
Corner Joint Detail.



## ART MODERNE

Tube Ø 32mm HEX	Dimensions (mm)			Bar Config	Pipe Centres	Element Wattage	ΔT 50°C Watts/BTU's	ΔT 60°C BTU's	£ ex VAT Chrome	£ inc VAT Chrome	Stock Info
	H	W	D								
OG010A	836	550	145	4	450	100	211 / 720	910	1219.00	1462.80	👇
OG010B	836	700	145	4	600	125	247 / 843	1065	1250.00	1500.00	👇
OG010C	986	700	145	4	600	125	263 / 897	1134	1272.00	1526.40	👇

# FAIRING WALL MOUNTED PJ010A / PJ021B / PJ021C

The Fairing is an understated classic towel rail. Brass manufactured with a Chrome plating as standard. A full range of bespoke finishes are available at an additional cost, please see page 145 for other options. Further PJ models are available via our hand crafted service, including floor and wall mounted Fairing models and much more. Please speak with our sales team about these custom built models.



Image showing PJ021B hand finished in Brushed Brass.



PJ021C 5 Bars

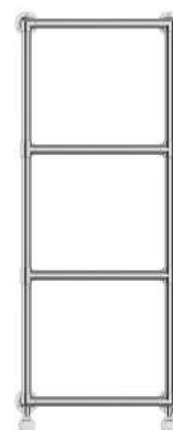

PJ021B 4 Bars

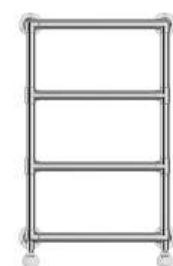

PJ010A 4 Bars



For valves and electric elements please see the Additions section - VL003 pictured.



PJ - Plain Joint

## FAIRING

Tube Ø 31.8mm	Dimensions (mm)			Bar Config	Pipe Centres	Element Wattage	ΔT 50°C Watts/BTU's	ΔT 60°C BTU's	£ ex VAT Chrome	£ inc VAT Chrome	Stock Info
	H	W	D								
PJ010A	750	500	125	4	425	100	100 / 576	730	913.50	1096.20	
PJ021B	1275	525	125	4	450	125	239 / 815	1033	1127.00	1352.40	
PJ021C	1575	525	125	5	450	125	292 / 996	1262	1333.50	1600.20	

# PENTHOUSE WALL MOUNTED LG018 / OG020

This characterful robustly British towel warmer hails quality and craftsmanship. Made for you with your choice of the Legacy or Originals ball joint (pictured). Brass manufactured with a Chrome finish as standard. Bespoke finishes are available at an additional cost, please see page 145 for other finishes.



For valves and electric elements please see the Additions section - VL018 pictured.



## PENTHOUSE

Tube Ø 31.8 + 25.4mm	Dimensions (mm)			Bar Config	Pipe Centres	Element Wattage	ΔT 50°C Watts/BTU's	ΔT 60°C BTU's	£ ex VAT Chrome	£ inc VAT Chrome	Stock Info
	H	W	D								
LG018	1100	550	100	20	500	200	532 / 1815	2294	1707.00	2048.40	
OG020	1100	550	100	18	500	200	532 / 1815	2126	1902.00	2282.40	

# NEXUS GRAND III WALL MOUNTED TM003

When combinations are right, something good happens. This towel rail has a great heat output from a white twin column radiator inset. It is skilfully combined in a brass framework and Chrome Plated. Other radiator colours and bespoke metallic finishes are available at an additional cost, please see pages 145 & 146.



For valves and electric elements please see the Additions section - VL008 pictured.

BR C E D  30

## NEXUS GRAND III

Tube Ø 25.4 + 15mm	Dimensions (mm)			Sections	Pipe Centres	Element Wattage	ΔT 50°C Watts/BTU's	ΔT 60°C BTU's	£ ex VAT Chrome	£ inc VAT Chrome	Stock Info
	H	W	D								
TM003	900	525	142-160	8	500	400	726 / 2477	3131	1184.00	1420.80	

## VINTAGE WALL MOUNTED LG010B

This Chrome finished Brass tubed simple design with Legacy ball joints would sit happily in either a traditional or more contemporary setting. Other bespoke metallic finishes are available at an additional cost, please see page 145.



For valves and electric elements please see the Additions section - VL008 pictured.



### VINTAGE

Tube Ø 31.8	Dimensions (mm)			Bar Config	Pipe Centres	Element Wattage	ΔT 50°C Watts/BTU's	ΔT 60°C BTU's	£ ex VAT Chrome	£ inc VAT Chrome	Stock Info
	H	W	D								
LG010B	750	475	105	4	400	100	169 / 577	729	776.00	931.20	✓

# SEQUEL III WALL MOUNTED TM005

The Sequel III is manufactured from high quality Brass, Chrome finished as standard with a white three column mild steel inset radiator. It has a high heat output with plenty of towel drying space. Other radiator colours and bespoke metallic finishes are available at an additional cost, please see page 145 & 146.



For valves and electric elements please see the Additions section - VL006 pictured.

BR C E D  30

## SEQUEL III

Tube Ø 25.4 + 15mm

	Dimensions (mm)			Sections	Pipe Centres	Element Wattage	ΔT 50°C Watts/BTU's	ΔT 60°C BTU's	£ ex VAT Chrome	£ inc VAT Chrome	Stock Info
	H	W	D								
TM005	1000	550	182-200	5	475	400	741 / 2528	3196	1409.00	1690.80	

# SEQUEL V WALL MOUNTED TM006

The Sequel V has Legacy ball joints and emits a fine traditional sense of style. Manufactured from high quality Brass, Chrome finished as standard with a White three column Mild Steel inset radiator. Other radiator colours and bespoke metallic finishes are available at an additional cost, please see page 145 & 146.



For valves and electric elements please see the Additions section - VL018 pictured.

BR C E D  30

## SEQUEL V

Tube Ø 25.4	Dimensions (mm)			Sections	Pipe Centres	Element Wattage	ΔT 50°C Watts/BTU's	ΔT 60°C BTU's	£ ex VAT Chrome	£ inc VAT Chrome	Stock Info
	H	W	D								
TM006	1000	525	191-209	5	475	400	716 / 2443	3088	1364.00	1636.80	

## BASIN STANDS

### WALL AND FLOOR MOUNTED HEATED OR UNHEATED

Vogue have developed a range of Handcrafted Brass basin stands produced to order. The designs illustrated can be altered to suit your exact requirements with a choice of metallic finish. Other finishes are available, please see page 145.

Please contact our team for further information and a specific quotation.





RICHMOND BSS001



LINEA RICHMOND BSS002



MAYFAIR BSS003



KENSINGTON BSS004



BELGRAVIA BSS005



CHELSEA BSS006

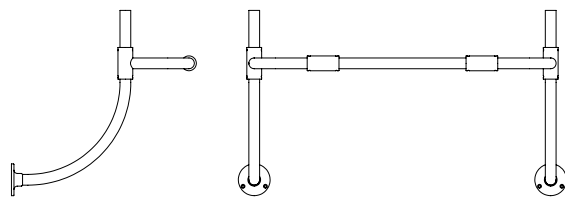

BESPOKE TO YOUR BASIN



CITY BSS007

# SHOWER CURTAIN RAILS

Our handmade range of shower curtain rails are beautifully engineered from high quality Brass tubing for longevity. As standard they are finished in Chrome, other finishes are available, see page 145. Please talk to us if you require non standard sizes.

## OVAL CEILING MOUNTED - SCR 1

Ø 25.4mm

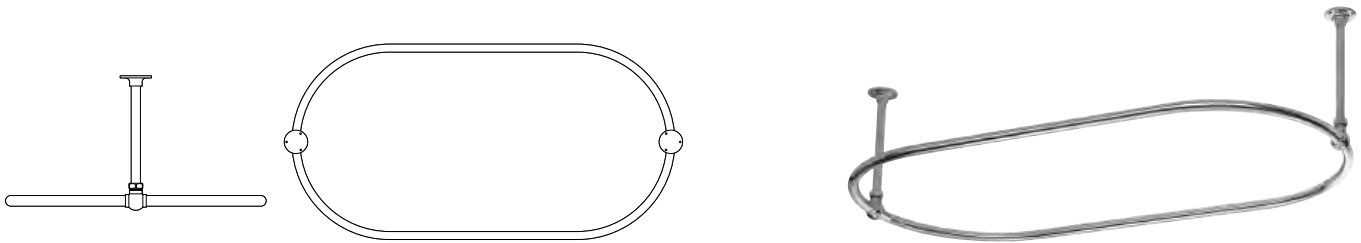

## SINGLE ENDED OVAL WALL AND CEILING MOUNTED - SCR 2

Ø 25.4mm

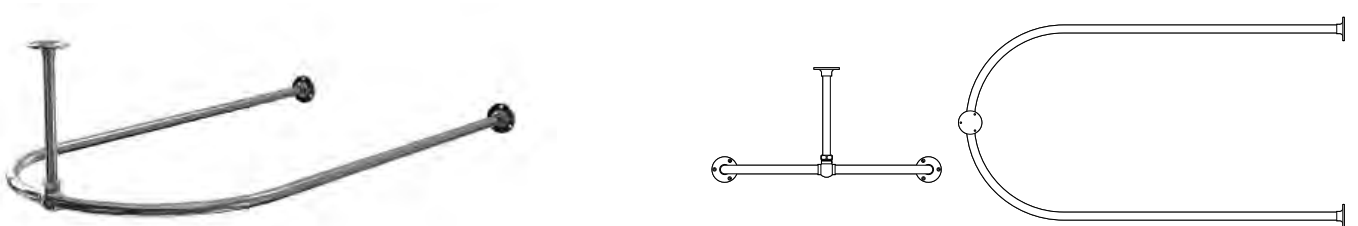

## STRAIGHT WALL MOUNTED- SCR 3

Ø 31.8mm



## CURVED CORNER WALL MOUNTED - SCR 4

Ø 25.4mm



## CIRCULAR WALL MOUNTED - SCR 5

Ø 25.4mm

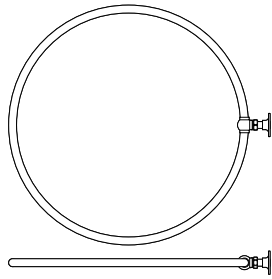

## RIGHT ANGLE WALL MOUNTED - SCR 6

Ø 25.4mm

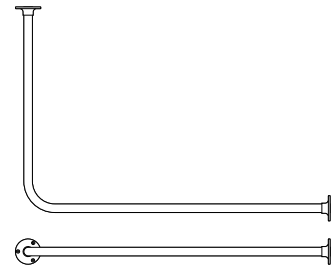

### SHOWER CURTAIN RAILS

	Dimensions (mm)			Description	£ ex VAT Chrome	£ inc VAT Chrome	Stock Info
	H	W	D				
SCR 1.1	325	1275	625	Oval shape mounted to ceiling	635.00	762.00	👤
SCR 1.2	325	1625	625	Oval shape mounted to ceiling	654.00	784.80	👤
SCR 2.1	338	1238	675	Single ended oval shape mounted to wall and ceiling	620.00	744.00	👤
SCR 2.2	338	1538	675	Single ended oval shape mounted to wall and ceiling	682.00	818.40	👤
SCR 3.1	75	1700	75	Straight wall mounted bar	384.00	460.80	👤
SCR 3.2	75	2000	75	Straight wall mounted bar	432.00	518.40	👤
SCR 4.1	75	938	938	Round curve for corner applications	421.00	505.20	👤
SCR 4.2	75	1238	1238	Round curve for corner applications	451.00	541.20	👤
SCR 5.1	75	775 Ø	827	Circular wall mounted	395.00	474.00	👤
SCR 5.2	75	925 Ø	977	Circular wall mounted	432.00	518.40	👤
SCR 6.1	75	938	638	Right angled curve for corner applications	408.00	489.60	👤
SCR 6.2	75	1238	638	Right angled curve for corner applications	443.00	531.60	👤
SCR 6.3	75	1538	638	Right angled curve for corner applications	482.00	578.40	👤





VOGUE UK

EST | 1990

## DESIGNER RADIATORS

Looking for a real statement piece?

Our exclusive designer radiators are constantly leading the trend in interior design. Created by some of the UK's most celebrated interior designers, they are guaranteed to turn heads.

We have put together a collection of radiators that embrace the latest in materials and technology. Designs that work well, whilst enhancing the rooms where they're installed. If you're looking for a focal point or wanting to upgrade the heating of your whole home, our designer offering has attractive possibilities for you.

# ORIEL AU052

A radiator less ordinary; Oriel gives neat storage capabilities within a design that offers a focal point. The Aluminium heated surround comes in either Textured Black or White. The wooden shelf details can be used for displaying your bathroom or interiors accessories.



For valves please see the Additions section - VL003 pictured.

Textured  
White

Textured  
Black

AL H 10

\*Note: The shelves on Oriel are made of natural wood textures, which may differ from the image shown and from product to product.

## ORIEL

	Dimensions (mm)			No. of Shelves	Pipe Centres	$\Delta T$ 50°C Watts/BTUs	$\Delta T$ 60°C BTUs	£ ex VAT Textured White or Black	£ inc VAT Textured White or Black	Stock Info
	H	W	D							
AU052	1175	500	150	3	50	898 / 3064	3882	1564.87	1877.84	✓

# ORDINATE MD005

A bold and clean lined tubular radiator. The Ordinate will integrate well into any room of the house and is available in two widths. Manufactured as single or double versions in White Sparkle Textured or Anthracite.



Double panel option in White Sparkle Textured.



MS C 15



For valves see the Additions section VL003 pictured.



Clip-on Robe Hook AC031 £52.00 ex VAT, £62.40 inc VAT



Clip-on Towel Bars:  
AC023B 305mm  
£141.00 ex VAT, £169.20 inc VAT  
AC023C 395mm  
£152.00 ex VAT, £182.40 inc VAT

## ORDINATE

Tube Ø 22 +32mm	Dimensions (mm)			Bar Config	End to End Connections	ΔT 50°C Watts/BTU's	ΔT 60°C BTU's	£ Anthracite		£ White Sparkle Textured		Stock Info
	H	W	D					ex VAT	inc VAT	ex VAT	£ inc VAT	
MD005	1800	525	113-128	12	525	676 / 2307	2915	435.00	522.00	478.00	573.60	✓
MD005	1800	595	113-128	13	595	734 / 2504	3166	495.00	594.00	514.00	616.80	✓
MD005DP Double	1800	525	99	12-12	525	914 / 3119	3942	786.00	943.20	849.00	1018.80	✓
MD005DP Double	1800	595	99	13-13	595	992 / 3146	3976	883.00	1059.60	941.00	1129.20	✓

# FLY LINE VERTICAL DR003

Fly Line is a strong, minimalist design ideal for contemporary properties. Available in single or double panel versions with the double panel offering an increased heat output. Colour options are available on single panel Flyline versions only please see page 146.



## FLY LINE VERTICAL



Tube Ø 38mm □70 x 11mm	Dimensions (mm)			No. of sections	End to End connections	ΔT 50°C Watts/BTU's	ΔT 60°C BTU's	£ Anthracite		£ White		Stock Info
	H	W	D					ex VAT	inc VAT	ex VAT	inc VAT	
DR003 (single panel)	1800	224	71	3	224	402 / 1372	1734	278.00	333.60	276.00	331.20	✓
DR003 (single panel)	1800	376	71	5	376	670 / 2286	2890	380.00	456.00	375.00	450.00	✓
DR003 (single panel)	1800	528	71	7	528	938 / 3200	4045	481.00	577.20	476.00	571.20	✓
DR003 (single panel)	1800	680	71	9	680	1206 / 4115	5201	582.00	698.40	576.00	691.20	✓
DR003DP (double panel)	1800	224	71	3	224	627 / 2139	2704	438.00	525.60	436.00	523.20	✓
DR003DP (double panel)	1800	376	71	5	376	1045 / 3566	4507	638.00	765.60	636.00	763.20	✓
DR003DP (double panel)	1800	528	71	7	528	1463 / 4992	6310	836.00	1,003.20	833.00	999.60	✓
DR003DP (double panel)	1800	680	71	9	680	1881 / 6418	8112	1,034.00	1,240.80	1,030.00	1,236.00	✓

# FLY LINE HORIZONTAL DR004

Flyline horizontal is available both single or double panel in white or anthracite as standard. Colour options are available on single panel Flyline versions only please see page 146.



For valves please see the Additions section - VL003 pictured.

White

Anthracite



## FLY LINE HORIZONTAL

Tube Ø 38mm □ 70 x 11mm	Dimensions (mm)			No. of sections	Pipe centres	ΔT 50°C Watts/BTU's	ΔT 60°C BTU's	£ Anthracite		£ White		Stock Info
	H	W	D					ex VAT	inc VAT	ex VAT	inc VAT	
DR004 (single panel)	452	900	63	6	850	420 / 1433	1811	315.00	378.00	313.00	375.60	✓
DR004 (single panel)	452	1200	63	6	1150	552 / 1883	2381	357.00	428.40	354.00	424.80	✓
DR004 (single panel)	604	900	63	8	850	560 / 1911	2415	381.00	457.20	379.00	454.80	✓
DR004 (single panel)	604	1200	63	8	1150	736 / 2511	3174	435.00	522.00	432.00	518.40	✓
DR004DP (double panel)	452	900	112	6	850	654 / 2231	2821	531.00	637.20	528.00	633.60	✓
DR004DP (double panel)	452	1200	112	6	1150	858 / 2927	3700	604.00	724.80	601.00	721.20	✓
DR004DP (double panel)	604	900	112	8	850	872 / 2975	3761	666.00	799.20	664.00	796.80	✓
DR004DP (double panel)	604	1200	112	8	1150	1144 / 3903	4934	762.00	914.40	759.00	910.80	✓

# FLY LINE II VERTICAL DR001

Manufactured from high quality Aluminium, Fly Line II offers a supreme heat output and sleek good looks. Available in White or Anthracite and as single or double panelled, in a variety of widths.

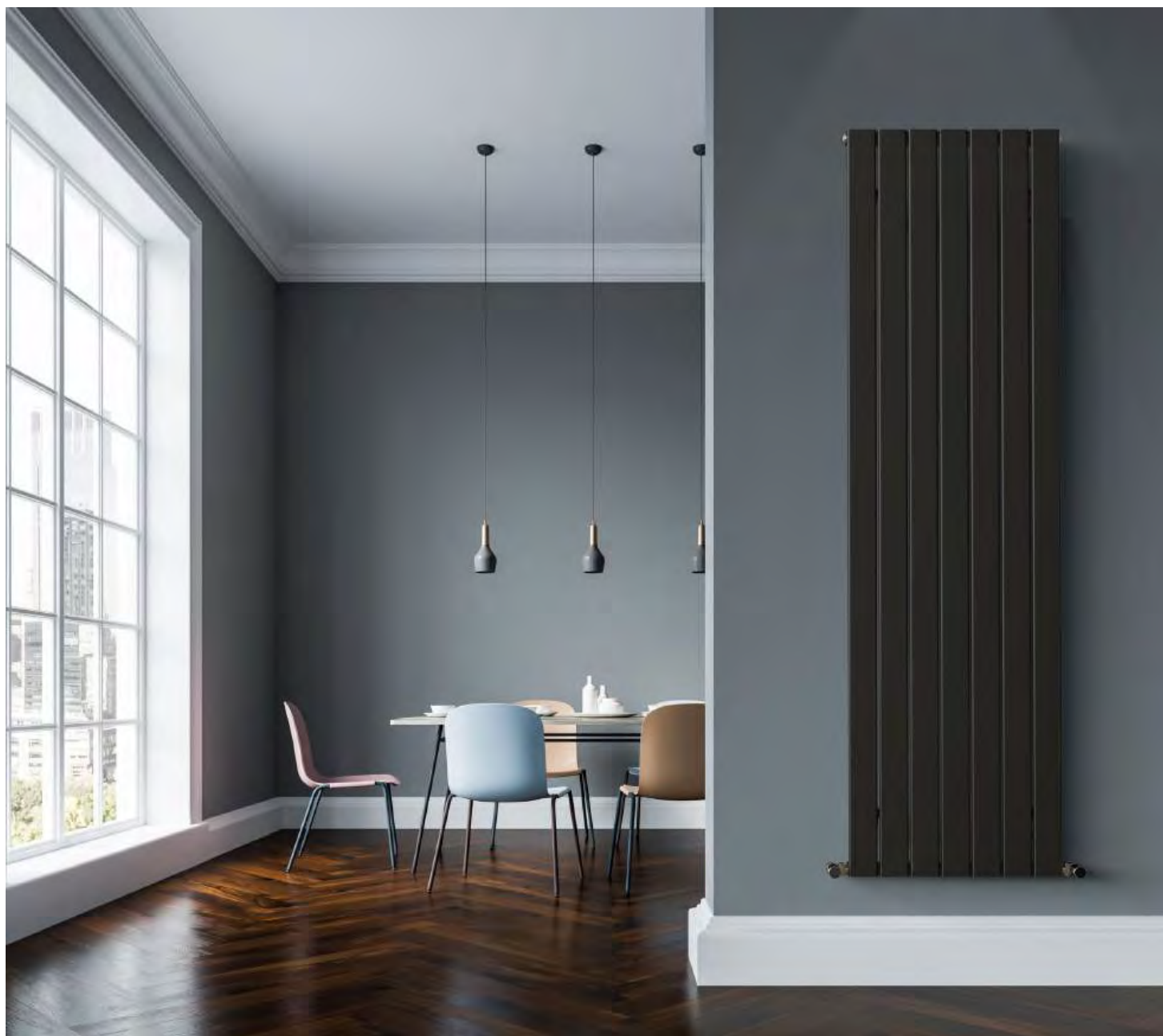

For valves please see the Additions section - VL003 pictured.



## FLY LINE II VERTICAL

Tube Ø 30mm □ 70 x 39.5 / 58mm	Dimensions (mm)			No. of sections	End to End connections	ΔT 50°C Watts/BTU's	ΔT 60°C BTU's	£ White / Anthracite		Stock Info
	H	W	D					ex VAT	inc VAT	
DR001SP (single panel)	1800	218	66	3	218	642 / 2190	2775	246.00	295.20	✓
DR001SP (single panel)	1800	366	66	5	366	1070 / 3651	4626	374.00	448.80	✓
DR001SP (single panel)	1800	514	66	7	514	1499 / 5113	6478	502.00	602.40	✓
DR001SP (single panel)	1800	662	66	9	662	1927 / 6574	8329	633.00	759.60	✓
DR001DP (double panel)	1800	218	92	3	218	1109 / 3783	4793	331.00	397.20	✓
DR001DP (double panel)	1800	366	92	5	366	1849 / 6308	7992	513.00	615.60	✓
DR001DP (double panel)	1800	514	92	7	514	2589 / 8833	11191	694.00	832.80	✓
DR001DP (double panel)	1800	662	92	9	662	3329 / 11358	14391	879.00	1054.80	✓

# FLY LINE II HORIZONTAL DR002

Available in single or double panel versions, the Fly Line II Horizontal is a fresh alternative to a conventional radiator. The long parallel lines and structured silhouette create a contemporary approach to the classic radiator profile we all know.



For valves please see the Additions section - VL003 pictured.

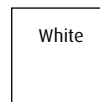

## FLY LINE II HORIZONTAL

Tube Ø 30mm □ 70 x 39.5 / 58mm	Dimensions (mm)			No. of sections	Pipe centres	ΔT 50°C Watts/BTU's	ΔT 60°C BTU's	£ White / Anthracite		Stock Info
	H	W	D					ex VAT	inc VAT	
DR002SP (single panel)	440	900	75	6	870	680 / 2319	2938	254.00	304.80	✓
DR002SP (single panel)	440	1200	75	6	1170	881 / 3006	3809	316.00	379.20	✓
DR002SP (single panel)	588	900	75	8	870	906 / 3092	3918	324.00	388.80	✓
DR002SP (single panel)	588	1200	75	8	1170	1175 / 4009	5079	405.00	486.00	✓
DR002DP (double panel)	440	900	122	6	870	1161 / 3960	5017	357.00	428.40	✓
DR002DP (double panel)	440	1200	122	6	1170	1513 / 5163	6542	439.00	526.80	✓
DR002DP (double panel)	588	900	122	8	870	1548 / 5281	6691	460.00	552.00	✓
DR002DP (double panel)	588	1200	122	8	1170	2018 / 6886	8725	569.00	682.80	✓

# SERENADE DR008

Serenade is a vertical contemporary design radiator, manufactured from high quality Mild Steel with finish options of Chrome, Matt Black & White. Please see page 146 for colour options.

Towel Bar Optional Accessory  
 Chrome, Black or White  
 AC039A (266mm wide)  
 AC039B (375mm wide)  
 £57.00 ex VAT, £68.40 inc VAT



Matt Black



White



For valves please see the Additions section - VL014 pictured.



**MILD STEEL**  
**SUPPLEMENTS** £ = Chrome + >



Bright Nickel:  
 + £221.00 ex VAT  
 + £265.20 inc VAT



Brushed Nickel:  
 + £309.00 ex VAT  
 + £370.80 inc VAT

## SERENADE

Tube Ø 30mm □ 40 x 10mm	Dimensions (mm)			Bar Config	End to End Connections	ΔT 50°C Watts/BTUs		ΔT 60°C BTU's		£ Chrome		£ White / Black		Stock Info
	H	W	D			Chrome	Painted	Chrome	Painted	ex VAT	inc VAT	ex VAT	inc VAT	
DR008	1200	252	70	5	252	242 / 826	367 / 1252	1044	1583	331.00	397.20	255.00	306.00	✓
DR008	1200	358	70	7	358	339 / 1157	515 / 1757	1462	2221	382.00	458.40	286.00	343.20	✓
DR008	1800	252	70	5	252	351 / 1198	533 / 1819	1514	2299	391.00	469.20	310.00	372.00	✓
DR008	1800	358	70	7	358	491 / 1675	746 / 2545	2118	3217	593.00	711.60	369.00	442.80	✓

# LURE DOUBLE DR020DP

A modern designer radiator with twin rows of oval tubes for elegance and high output available in White or Anthracite. Manufactured from Mild Steel, suitable for closed heating systems.



Anthracite



For valves please see the Additions section - VL003 pictured.



## LURE DOUBLE

Tube Ø 32mm ○ 25 x 50mm	Dimensions (mm)			Bar Config	End to End Connections	ΔT 50°C Watts/BTUs	ΔT 60°C BTU's BTUs	£ White / Anthracite		Stock Info
	H	W	D					ex VAT	inc VAT	
DR020DP	1800	352	105-110	5	352	1014 / 3460	4373	506.00	607.20	✓

# ASTUTE HORIZONTAL ALUMINIUM DR036

Provides great efficiency, easy to install with in lightweight Aluminium. The design of the radiator has a low water content, enabling a quick heat up time. Wall mounted and available single or double panel in your choice of White or Anthracite finish.



For valves please see the Additions section - VL003 pictured.

AL H 10

## ASTUTE HORIZONTAL

	Dimensions (mm)			Sections	End to End connections	ΔT 50°C Watts/BTU's	ΔT 60°C BTU's	£ ex VAT		£ inc VAT		Stock Info
	H	W	D					White	Anthracite			
DR036 (single panel)	600	565	76.5	6	565	506 / 1726	2182	332.00	398.40	345.00	414.00	✓
DR036 (single panel)	600	755	76.5	8	755	674 / 2300	2914	395.00	474.00	403.00	483.60	✓
DR036 (single panel)	600	945	76.5	10	945	842 / 2873	3640	465.00	558.00	480.00	576.00	✓
DR036 (single panel)	600	1135	76.5	12	1135	1011 / 3450	4371	537.00	644.40	553.00	663.60	✓
DR036 (single panel)	600	1325	76.5	14	1325	1147 / 3914	4958	607.00	728.40	625.00	750.00	✓
DR036 (single panel)	600	1515	76.5	16	1515	1342 / 4579	5801	676.00	811.20	699.00	838.80	✓
DR036DP (double panel)	600	560	117.5	6	560	841 / 2869	3636	419.00	502.80	428.00	513.60	✓
DR036DP (double panel)	600	748	117.5	8	748	1121 / 3825	4846	515.00	618.00	526.00	631.20	✓
DR036DP (double panel)	600	936	117.5	10	936	1401 / 4780	6057	611.00	733.20	624.00	748.80	✓
DR036DP (double panel)	600	1124	117.5	12	1124	1654 / 5643	7150	727.00	872.40	741.00	889.20	✓
DR036DP (double panel)	600	1312	117.5	14	1312	1908 / 6510	8248	826.00	991.20	844.00	1012.80	✓

# ASTUTE COMPACT ALUMINIUM DR034

Compact Aluminium radiator to fit the smallest of space while providing the benefits of low water content and quick heat up. Available in Textured Black, Anthracite and White. Please note elements can only be fitted in a tapping at the bottom right side of the radiator. Towel bar accessory available in Chrome, Textured Black, Anthracite or White AC064 £50.00 ex VAT, £60.00 inc VAT.



Textured Anthracite



Textured White



Textured Black



For valves and electric elements please see the Additions section - VL033 pictured.



## ASTUTE COMPACT

	Dimensions (mm)			Sections	End to End connections	Element wattage	$\Delta T$ 50°C Watts/BTU's	$\Delta T$ 60°C s BTU's	£ ex VAT Colours	£ inc VAT Colours	Stock Info
	H	W	D								
DR034	1800	185	90	2	185	300	436 / 1488	1880	218.00	261.60	✓

# ASTUTE VERTICAL SINGLE DR035

Provides great efficiency, easy to install with its lightweight material and has low water content, enabling a quick heat up time. Single panel and wall mounted in your choice of White or Anthracite finish.



Optional Chrome  
Towel Bar

AC066 (320mm wide)  
£69.00 ex VAT, £82.80 inc VAT

AC066 (415mm wide)  
£91.00 ex VAT, £109.20 inc VAT

AC066 (510mm wide)  
£116.00 ex VAT, £139.20 inc VAT



## ASTUTE VERTICAL

	Dimensions (mm)			Sections	End to End connections	$\Delta T$ 50°C Watts/BTU's	$\Delta T$ 60°C BTU's	£ White		£ Anthracite		Stock Info
	H	W	D					ex VAT	inc VAT	ex VAT	inc VAT	
DR035	1800	280	76.5	3	280	843 / 2876	3644	343.44	412.13	352.98	423.58	✓
DR035	1800	375	76.5	4	375	1124 / 3835	4859	419.76	503.71	434.60	521.52	✓
DR035	1800	470	76.5	5	470	1405 / 4794	6074	496.08	595.30	514.10	616.92	✓



# ASTUTE VERTICAL DOUBLE DR035DP

Double Panel models complete the product offering, with the same White and Anthracite finish of the other three formats in the range. Specifiers utilise this tall double panel model in spaces where wall width is limited, yet a high heat output is required.



Optional Chrome  
Towel Bar

AC066DP (320mm wide)  
£78.00 ex VAT, £93.60 inc VAT

AC066DP (415mm wide)  
£107.00 ex VAT, £128.40 inc VAT

AC066DP (510mm wide)  
£133.00 ex VAT, £159.60 inc VAT



## ASTUTE VERTICAL DP

	Dimensions (mm)			Sections	End to End connections	ΔT 50°C Watts/BTU's	ΔT 60°C BTU's	£ White		£ Anthracite		Stock Info
	H	W	D					ex VAT	inc VAT	ex VAT	inc VAT	
DR035DP	1800	278	117.5	3	278	1441 / 4917	6229	484.42	581.30	495.02	594.02	✓
DR035DP	1800	372	117.5	4	372	1916 / 6537	8283	598.90	718.68	613.74	736.49	✓
DR035DP	1800	466	117.5	5	466	2348 / 8011	10150	714.44	857.33	731.40	877.68	✓



# MODE II FLOOR OR WALL MOUNTED CN027

Contemporary styling with sleek rounded tubes. Mode II has all the attributes of a great column radiator with edgy attitude. These wall hung radiators will complement many areas of the home. Available in White RAL 9016 and Metallic Anthracite as standard. Please see page 146 for other colour options.

## THREE HEIGHTS - 450MM, 550MM AND 1800MM

Available in a variety of widths

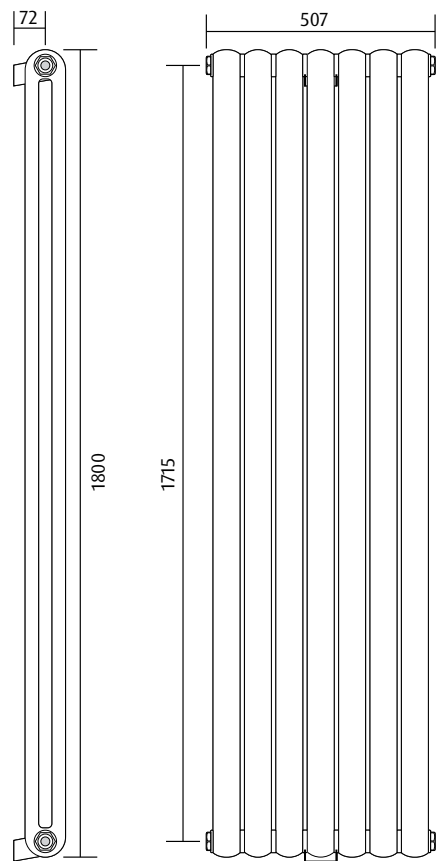

1800mm High

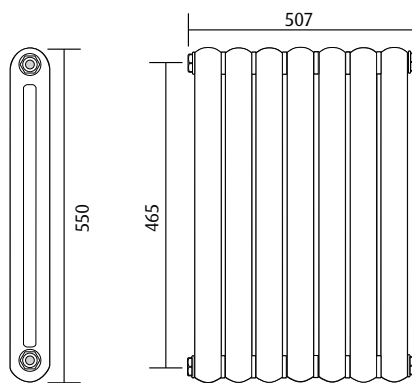

550mm High

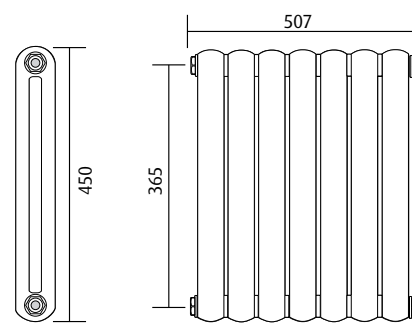

450mm High

Feet - White or Anthracite  
AC038: £35.00 ex VAT, £42.00 inc VAT



Contemporary or Classic thermostatic valve options to suit Mode II. See page 143.



### MODE II

	Dimensions (mm)			Number of Sections	ΔT 50°C Watts/BTU's	ΔT 60°C BTU's	£ ex VAT White / Anthracite	£ inc VAT White / Anthracite	Stock Info
	H	W	D						
CN027	450	507	90	7	398 / 1358	1716	324.50	389.40	✓
CN027	450	785	90	11	625 / 2133	2695	434.50	521.40	✓
CN027	450	993	90	14	796 / 2716	3433	631.40	757.68	✓
CN027	450	1202	90	17	966 / 3296	4166	763.40	916.08	✓
CN027	550	507	90	7	505 / 1723	2178	366.30	439.56	✓
CN027	550	785	90	11	793 / 2706	3420	489.50	587.40	✓
CN027	550	993	90	14	1009 / 3443	4352	717.20	860.64	✓
CN027	550	1202	90	17	1226 / 4183	5287	863.50	1036.20	✓
CN027	1800	229	90	3	922 / 3146	3976	386.10	463.32	✓
CN027	1800	370	90	5	1538 / 5248	6633	572.00	686.40	✓
CN027	1800	507	90	7	2153 / 7346	9285	754.60	905.52	✓



Metallic Anthracite option (non-textured)



Optional Towel Bar - White, Chrome or Anthracite



- AC034A 60 x 200mm wide
- AC034B 60 x 340mm wide
- AC034C 60 x 480mm wide

£71.00 ex VAT, £85.20 inc VAT



Mode suits traditional properties, yet also looks great in contemporary settings. Heights range from 300mm great for under window sills, to a 1800mm tall version. There are many sizes in between.

Available in a wide range of sizes, so you can choose a radiator which exactly suits your space and required heat output. The standard colour finish is white RAL 9016. Other RAL colours are available. Contemporary colours available on 2, 3 & 4 column only. Colour finish options are subject to an eight week lead time, Sizes are subject to manufacturing tolerances.

Wall brackets are included, feet, other fixing accessories and non standard sizes include 5 and 6 columns ranging from 300mm - 2000mm high and detailed on the next pages. For valve finishing options see page 139-144.

# MODE

	Dimensions (mm)			Number of Sections	ΔT 50°C Watts/BTU's	ΔT 60°C BTU's	£ ex VAT White	£ inc VAT White	Stock Info
	H	W	D						
<b>2 COLUMN RADIATORS</b>									
2C-050-10	500	460	68	10	371 / 1266	1600	309.10	370.92	✓
2C-050-18	500	812	68	18	688 / 2347	2967	478.50	574.20	✓
2C-050-22	500	988	68	22	817 / 2788	3524	565.40	678.48	✓
2C-060-10	600	460	68	10	440 / 1501	1898	321.20	385.44	✓
2C-060-14	600	636	68	14	616 / 2102	2657	409.20	491.04	✓
2C-060-18	600	812	68	18	792 / 2702	3416	493.90	592.68	✓
2C-060-22	600	988	68	22	968 / 3303	4175	579.70	695.64	✓
2C-060-24	600	1076	68	24	1056 / 3603	4554	631.40	757.68	✓
2C-060-28	600	1252	68	28	1232 / 4204	5313	719.40	863.28	✓
2C-180-6	1800	284	68	6	774 / 2641	3338	371.80	446.16	✓
2C-180-8	1800	372	68	8	1032 / 3521	4451	477.40	572.88	✓
2C-180-10	1800	460	68	10	1290 / 4401	5563	546.70	656.04	✓
2C-180-12	1800	548	68	12	1548 / 5282	6676	635.80	762.96	✓
<b>3 COLUMN RADIATORS</b>									
3C-050-14	500	636	100	14	720 / 2457	3105	477.40	572.88	✓
3C-050-18	500	812	100	18	926 / 3160	3994	575.30	690.36	✓
3C-050-22	500	988	100	22	1131 / 3859	4878	677.60	813.12	✓
3C-050-24	500	1076	100	24	1234 / 4210	5322	732.60	879.12	✓
3C-050-28	500	1252	100	28	1440 / 4913	6210	838.20	1005.84	✓
3C-060-10	600	460	100	10	609 / 2078	2626	391.60	469.92	✓
3C-060-14	600	636	100	14	852 / 2907	3674	497.20	596.64	✓
3C-060-18	600	812	100	18	1097 / 3743	4731	605.00	726.00	✓
3C-060-20	600	900	100	20	1218 / 4156	5253	660.00	792.00	✓
3C-060-24	600	1076	100	24	1462 / 4988	6305	768.90	922.68	✓
3C-060-30	600	1340	100	30	1827 / 6234	7879	932.80	1119.36	✓
3C-075-10	750	460	100	10	750 / 2559	3235	441.10	529.32	✓
3C-075-14	750	636	100	14	1050 / 3583	4528	565.40	678.48	✓
3C-075-18	750	812	100	18	1350 / 4606	5822	690.80	828.96	✓
3C-075-22	750	988	100	22	1650 / 5630	7116	814.00	976.80	✓
3C-075-26	750	1164	100	26	1950 / 6653	8410	948.20	1137.84	✓
3C-180-8	1800	372	100	8	1412 / 4818	6090	559.90	671.88	✓
3C-180-10	1800	460	100	10	1764 / 6019	7608	662.20	794.64	✓
3C-180-12	1800	548	100	12	2117 / 7223	9130	765.60	918.72	✓
<b>4 COLUMN RADIATORS</b>									
4C-030-20	300	900	140	20	850 / 2900	3666	1117.60	1341.12	✓
4C-030-30	300	1340	140	30	1275 / 4350	5499	1676.40	2011.68	✓
4C-060-14	600	636	140	14	1147 / 3914	4947	635.80	762.96	✓
4C-060-18	600	812	140	18	1475 / 5033	6361	745.80	894.96	✓
4C-060-20	600	900	140	20	1638 / 5589	7064	814.00	976.80	✓
4C-060-24	600	1076	140	24	1966 / 6708	8479	963.60	1156.32	✓
4C-075-14	750	636	140	14	1417 / 4835	6111	700.70	840.84	✓
4C-075-18	750	812	140	18	1822 / 6217	7858	874.50	1049.40	✓
4C-075-22	750	988	140	22	2227 / 7599	9605	1047.20	1256.64	✓
4C-075-26	750	1164	140	26	2632 / 8980	11351	1223.20	1467.84	✓

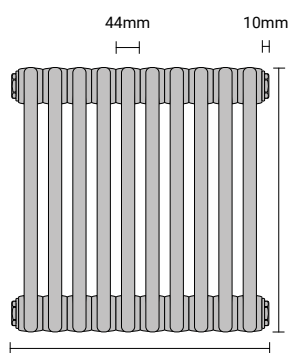

Width = No of sections x 44mm + 2 x 10mm

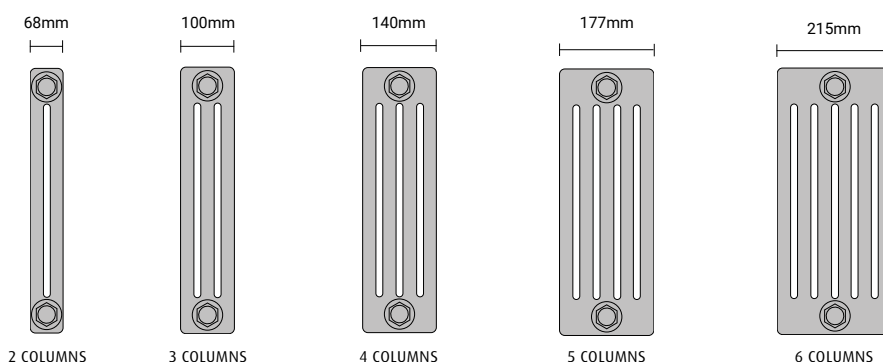

2 COLUMNS

3 COLUMNS







4 COLUMNS

5 COLUMNS

6 COLUMNS

This service gives the opportunity to order non standard sizes. Choose from wall or floor standing. These radiators are supplied in white RAL 9016. Coloured finishes are available, please see page 146 for colour options. Please note, contemporary colours available on 2, 3 & 4 column only. The lead time for delivery is approximately eight weeks. The sections cannot be joined on site. We only supply complete radiators, practical considerations need to be given to weight, carriage, handling and accessibility. Where necessary large radiators can be supplied in module format.

**Maximum number of radiator sections for bespoke models is 44.**

Accessories for Mode Column Radiators	£ ex VAT	£ inc VAT	Stock Info
 Column Radiator Feet AC028	90.00 per pair	108.40 per pair	✓
 Adjustable Feet AC024 Height from 90mm to 120mm. Must only be used with top retaining stay.	56.00 each	67.20 each	✓
 Base Plate Cover AC025 For use with adjustable feet (above).	13.00 each	15.60 each	✓
 Top Retaining Stay AC026 For use with adjustable feet.	20.00 each	24.00 each	✓
 Standing Brackets For use with glass walls etc...	POA	POA	✘
 Welded Feet - 2 Heights Available (75mm or 140mm) Up to 20 sections requires two feet 21 to 40 sections three feet 41 to 44 sections four feet	90.00 each	108.40 each	✘
 See Page 131 - 144 for our range of valves			✓

## CALCULATIONS FOR SIZING A RADIATOR

### REQUIRED OUTPUT IS 1200 WATTS

Space available is 1000 mm high x 750 mm wide.  
Approx radiator dimensions 900mm high x 600mm wide.  
(Taking into account space for valves)

### NUMBER OF SECTIONS POSSIBLE

Width (600mm) divide by 45mm per section  
+ allowance for each side.  
600 - 24 divided by 45 = 12 sections.

### HEAT OUTPUT PER SECTION

Divide your required output by sections.  
1200 watts divided by 12 = 100 watts per section.

### SELECTING YOUR RADIATOR SECTION

4-750 @102 watts per section.  
Therefore 12 sections @102 per section = 1224 watts  
@ 50 degrees C delta T.

### PRICE CALCULATION

12 x 43.00 = 516.00 ex VAT,  
Plus feet if floor standing and any other non standard support brackets you may require.

### DIMENSIONS

The nominal overall length of a radiator = number of section  
x 45mm = 24mm for reducing bushes (12mm each end).  
Subject to manufacturing tolerance of +/- 0.7mm (1.5%)  
per section.



## MODE SECTIONS

	Dimensions (mm)		$\Delta T$ 50°C Watts/BTU's	$\Delta T$ 60°C BTU's	£ ex VAT White	£ inc VAT White
	H	D				
<b>2 COLUMN SECTION</b>						
2-300	300	65	24 / 82	104	35.31	42.37
2-400	400	65	31 / 106	134	35.31	42.37
2-500	500	65	37 / 126	160	35.31	42.37
2-600	600	65	44 / 150	190	36.38	43.66
2-750	750	65	55 / 188	238	36.38	43.66
2-900	900	65	65 / 222	282	39.59	47.51
2-1000	1000	65	72 / 246	312	42.80	51.36
2-1200	1200	65	86 / 293	372	54.57	65.48
2-1500	1500	65	108 / 369	468	68.48	82.18
2-1800	1800	65	129 / 440	558	80.25	96.30
2-2000	2000	65	144 / 491	623	103.79	124.55
<b>3 COLUMN SECTION</b>						
3-300	300	105	33 / 113	143	42.80	51.36
3-400	400	105	42 / 143	181	40.66	48.79
3-500	500	105	52 / 177	224	39.59	47.51
3-600	600	105	61 / 208	264	40.66	48.79
3-750	750	105	75 / 256	325	47.08	56.50
3-900	900	105	90 / 307	389	53.50	64.20
3-1000	1000	105	99 / 338	429	55.64	66.77
3-1200	1200	105	118 / 403	511	71.69	86.03
3-1500	1500	105	147 / 502	637	88.81	106.57
3-1800	1800	105	177 / 604	766	104.86	125.83
3-2000	2000	105	197 / 672	852	118.77	142.52
<b>4 COLUMN SECTION</b>						
4-300	300	145	43 / 147	186	47.08	56.50
4-400	400	145	56 / 191	242	48.15	57.78
4-500	500	145	69 / 235	298	49.22	59.06
4-600	600	145	82 / 280	355	50.29	60.35
4-750	750	145	102 / 348	441	50.29	60.35
4-900	900	145	121 / 413	524	54.57	65.48
4-1000	1000	145	134 / 457	579	63.13	75.76
4-1200	1200	145	159 / 543	689	83.46	100.15
4-1500	1500	145	197 / 672	852	110.21	132.25
4-1800	1800	145	235 / 802	1017	132.68	159.22
4-2000	2000	145	260 / 887	1125	147.66	177.19
<b>5 COLUMN SECTION</b>						
5-300	300	185	52 / 177	224	53.50	64.20
5-400	400	185	68 / 232	294	54.57	65.48
5-500	500	185	83 / 283	359	56.71	68.05
5-600	600	185	98 / 334	424	59.92	71.90
5-750	750	185	121 / 413	524	66.34	79.61
5-900	900	185	143 / 488	619	73.83	88.60
5-1000	1000	185	158 / 539	683	80.25	96.30
5-1200	1200	185	188 / 641	813	102.72	123.26
5-1500	1500	185	232 / 792	1004	134.82	161.78
5-1800	1800	185	277 / 945	1198	160.50	192.60
5-2000	2000	185	307 / 1048	1329	176.55	211.86
<b>6 COLUMN SECTION</b>						
6-300	300	225	63 / 215	273	63.13	75.76
6-400	400	225	82 / 280	355	64.20	77.04
6-500	500	225	101 / 345	437	66.34	79.61
6-600	600	225	120 / 409	519	70.62	84.74
6-750	750	225	148 / 505	640	80.25	96.30
6-900	900	225	175 / 597	757	92.02	110.42
6-1000	1000	225	193 / 659	836	99.51	119.41
6-1200	1200	225	229 / 781	990	129.47	155.36
6-1500	1500	225	282 / 962	1220	162.64	195.17
6-1800	1800	225	334 / 1140	1446	193.67	232.40
6-2000	2000	225	369 / 1259	1596	211.86	254.23

# ECO MODULAR BARS WALL MOUNTED ELTB12V

Eco modular bars are available in Polished Stainless Steel or Matt Black in two widths. The bars are powered by SELV (Safety Extra Low Voltage) 12v connection and can be singular or linked to create multiple heated bars. Supplied with connections and 6m cable as standard. A 12v transformer is priced at 32.00 ex VAT, 38.40 inc VAT. IP44 when installed as per installation instructions.

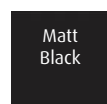

Round bar with mitred corner



Square bar with mitred corner

## MODULAR BARS

Tube Ø 32mm □ 40 x 25mm	Dimensions (mm)			Electric Element Wattage	£ ex VAT Matt Black	£ inc VAT Matt Black	£ ex VAT Polished SS	£ inc VAT Polished SS	Stock Info
	H	W	D						
ELTB12V ROUND	32 Ø	500	100	10.3 W	144.00	172.80	140.00	168.00	✓
ELTB12V ROUND	32 Ø	600	100	13.0 W	156.00	187.20	151.00	181.20	✓
ELTB12V SQUARE	40	500	100	10.3 W	171.00	205.20	166.00	199.20	✓
ELTB12V SQUARE	40	600	100	13.0 W	180.00	216.00	174.00	208.80	✓

## SIMPLICITY II WALL MOUNTED EL040 / EL045

Uncomplicated and chic. The linear styling of Simplicity adds a sense of sophistication to any room. Slimline and discreet it provides the comfort of warm fluffy towels or bathrobes. Manufactured in high quality Stainless Steel. This is electric drylined only.

Electrical components are covered by our two year warranty. IP44 when installed as per installation instructions. Delivered complete, no cover shroud necessary.



EL040



EL045



SS E

	Dimensions Height (mm)	Description	Power W	£ ex VAT Polished SS	£ inc VAT Polished SS	Stock Info
EL040 Round	1100	Round tube 30mm Ø	28-30	317.00	380.40	✓
EL040 Round	1500	Round tube 30mm Ø	42-44	346.00	415.20	✓
EL040 Round	1800	Round tube 30mm Ø	52-55	403.00	483.60	✓
EL045 Cube	1100	Square tube 30 x 30mm	33-35	395.00	474.00	✓
EL045 Cube	1500	Square tube 30 x 30mm	49-52	435.00	522.00	✓
EL045 Cube	1800	Square tube 30 x 30mm	64-68	491.00	589.20	✓

# ELECTRIC UNDERFLOOR HEATING

There is nothing that quite matches the comfort of warm feet when getting out of the bath or shower, especially in the cold winter months! Imagine stepping onto warm tiles controlled to the temperature you prefer.

Electric underfloor heating works by gently warming the mass of floor which in turn warms the rest of the room. Our underfloor heating kit is quick and easy to install. Ideally timed when you are fitting a new kitchen or bathroom. Electrical components are covered by a two year warranty.

kit includes

## HEATING KIT

- The correct size heating mat.
- Digital touch screen timer and thermostat.
- Floor sensor and floor sensor mounting pipe.
- Multimeter to check installation at every stage.
- Comprehensive installation manual and control card



## PUTTING YOU IN CONTROL

The digital touch screen, completely programmable timer and thermostatic controller enables you to fully regulate the temperature and control when the heating is on or off. The manual override means at the touch of a button the temperature can be higher or lower to suit as and when it is needed.

Product	Area Metre(s)	Rated Power Wattage Per Matt	£ ex VAT	£ inc VAT	Stock Info
EUFH150-01.0	1.0	150	200.20	240.24	✓
EUFH150-01.5	1.5	225	222.20	266.64	✓
EUFH150-02.0	2.0	300	237.60	285.12	✓
EUFH150-02.5	2.5	375	254.10	304.92	✓
EUFH150-03.0	3.0	450	273.90	328.68	✓
EUFH150-03.5	3.5	525	291.50	349.80	✓
EUFH150-04.0	4.0	600	309.10	370.92	✓
EUFH150-04.5	4.5	675	364.10	436.92	✓
EUFH150-05.0	5.0	750	378.40	454.08	✓
EUFH150-06.0	6.0	900	409.20	491.04	✓
EUFH150-07.0	7.0	1050	448.80	538.56	✓
EUFH150-08.0	8.0	1200	488.40	586.08	✓
EUFH150-09.0	9.0	1350	531.30	637.56	✓
EUFH150-10.0	10.0	1500	565.40	678.48	✓
EUFH150-12.0	12.0	1800	645.70	774.84	✓



# ENVIROVENT

## SILENT Design 100

- Silent elastic blocks
- Sealed for life ball bearings
- Back draught shutter and airflow guide vanes
- High performance and quality
- Incredibly silent running
- Energy efficient
- 8 Watts / 230 Volts
- IP45 rated



A range of 100mm domestic axial extract fans for wall or ceiling installations, designed to solve ventilation problems in WC's and bathrooms. Fitted with motors mounted on silent elastic blocks, the fans deliver incredibly silent running and exceptional performance and stylish design.

## ECO dMEV

- Up to 6 adjustable trickle speed settings
- Timer, humidity sensor and pull cord models
- Complies with Building Regulations. Part F for system 3 Continuous Mechanical Extract
- SAP Appendix Q eligible achieving a low specific fan power of 0.28 W/l/s
- Incredibly silent running - Below 20 dB(A)
- One fan for all situations, both walls and ceilings
- Low Energy DC 1.5 Watts - Low voltage version available
- 4 Interchangeable front panel trims



The ECO dMEV has been designed and developed to offer the market a constant volume, continuously running, decentralised extract fan for the lowest power consumption, the lowest noise and lowest lifecycle costs.

## SILENT MV

- Sound absorbent insulation
- Incredibly silent running
- 360° rotating connection box
- Sealed for life ball bearings
- Fitted with a two speed motor
- Complies with building regulations
- High performance with flexible location
- Easy installation and maintenance
- IP44 rated



The SILENT MV fan range offers one of the most versatile fan systems on the market today. Due to its flexibility it can be used in a multitude of small and medium fan installations. Especially advantageous in applications where the system may be running for long periods throughout the day, the acoustic benefits of the SILENT MV fans ensure that optimum comfort is achieved without the disturbance of noisy ventilation systems.

## SILENT 100

- Also available in silver on silent elastic blocks
- Sealed for life ball bearings
- Back draught shutter and airflow guide vanes
- High performance and quality
- Incredibly silent running
- Significant energy savings
- 8 Watts / 230 Volts or 13 Watts / 12 Volts options
- IP45 / IP57 SELV version



100mm domestic axial extract fans for wall or ceiling installations. Designed to solve ventilation problems in WC's and bathrooms. Fitted to motors mounted on silent elastic blocks, fans are incredibly silent running and exceptional performance.

## OPTIONAL Kits



ENV-WALL KIT



ENV-CEILING KIT



ENV-SOFIT KIT



ENV-3M FLEX



ENV-6M FLEX

Fan	Description	Airflow rates - l/s (m <sup>2</sup> /h)	£ ex VAT	£ inc VAT	Stock Info
<b>SILENT Design 100</b>					
SILDES100 S	White Standard	22 (85)	114.00	136.80	✓
SILDES100 SS	Silver Standard	22 (85)	137.00	164.40	✓
SILDES100 T	White Timer	22 (85)	143.00	171.60	✓
SILDES100 TS	Silver Timer	22 (85)	190.00	228.00	✓
SILDES100 HT	White Adjustable Humidity Sensor	22 (85)	184.00	220.80	✓
SILDES100 HTS	Silver Adjustable Humidity Sensor	22 (85)	245.00	294.00	✓
<b>ECO dMEV</b>					
Eco dMEV S	Standard	18 (65)	382.50	459.00	✓
Eco dMEV T	Adjustable Run-On Timer	18 (65)	423.00	507.60	🕒
Eco dMEV HT	Adjustable Humidity Sensor & Timer	18 (65)	487.00	584.40	🕒
Eco dMEV HTP	Pull Cord Adjustable Humidity Sensor & Timer	18 (65)	490.00	588.00	🕒
Eco dMEV S SELV	Standard (SELV)	18 (65)	543.00	651.60	🕒
Eco dMEV T SELV	Adjustable (SELV) Run-On Timer	18 (65)	580.00	696.00	🕒
Eco dMEV HT SELV	Adjustable (SELV) Humidity Sensor & Timer	18 (65)	714.00	856.80	✓
Eco dMEV HTP SELV	Pull Cord Adjustable (SELV) Humidity Sensor & Timer	18 (65)	715.00	858.00	✓
<b>SILENT MV</b>					
SILMV 160100 S	Silent 2 speed in line fan	50 (80)	166.00	199.20	✓
SILMV 160100 T	Silent single speed inline fan with adjustable timer	50 (80)	188.00	225.60	✓
SILMV 250100 S	Silent 2 speed in line fan	50 (80)	463.00	555.60	🕒
SILMV 250100 T	Silent single speed inline fan with adjustable timer	50 (80)	444.00	532.80	🕒
<b>SILENT 100</b>					
Silent-100 S	Standard	26 (95)	95.00	109.20	✓
Silent-100 T	Adjustable Timer	26 (95)	132.00	130.80	✓
Silent-100 HT	Adjustable Humidity Sensor	26 (95)	205.00	246.00	✓
Silent-100 PIR	PIR	26 (95)	244.00	292.80	🕒
Silent-100 SS SILVER	Silver Standard	26 (95)	107.00	128.40	✓
Silent-100 ST SILVER	Silver Adjustable Timer	26 (95)	147.00	176.40	✓
<b>OPTIONAL Kits</b>					
ENV-WALL KIT	Wall Grill & pipe		32.00	38.40	✓
ENV-CEILING KIT	Ceiling Vent, 6M Flex & 2 flex ties		30.00	36.00	✓
ENV-SOFIT KIT	Wall grill, 3M Flex & 2 flex ties		37.00	44.40	✓
ENV-3M FLEX	3 metre flex 100 dia		33.00	39.60	✓
ENV-6M FLEX	6 metre flex 100 dia		58.00	69.60	✓

Electrical components are covered by a two year warranty. Other fans and accessories are available on request.





VOGUE UK

EST | 1990

## ADDITIONS & INFORMATION

For the perfect finishing touch, enhance and complement your towel rail or radiator with our collection of high quality accessories and additions.

We offer matched valves in various formats for most of our towel rail finishes. This includes painted and metallic finishes in corner, straight and angled valves.

Hand crafted pieces can have valves and accessories finished by our team to match. This level of finishing sets the Vogue UK offering apart.

All electric, drylined and dual fuel options are catered for within many of our products. Our technical sales team are here to help you with specific questions.

Further information, technical drawings and our BTU calculator are easy to find at:

[www.vogueuk.co.uk](http://www.vogueuk.co.uk)

# ELECTRIC ELEMENT ONLY PRICES



## Standard Element

IP55 Suitable for zones 1 and 2 of the bathroom. Each standard element contains a preset surface temperature control along with a back up fail safe, this is the only temperature control supplied, for more flexibility over the surface temperature we recommend using our AC012 (rheostat), this will give you surface temperature modulation, when fitted into the electrical supply circuit.

Element Cable Length 1.5 MTR



## Heat Sensor Element

IPX5 suitable for zones 1 and 2 of the bathroom. Five temperature settings ranging from 30°C to 60°C. The device displays the temperature to which it is currently set and indicates the status of the heating cycle.

**Finish options:** Chrome, White, Black or Gold.

Element Cable Length 1.5 MTR



## Heat Sensor Element Cover Shroud

An optional accessory to hide the cable See page 156. Can be used when depth from wall to centre is the max of 70mm.



## Electronique Element

IP66 Suitable for zones 1 and 2 of the bathroom. The standard Electronique element is set to a constant surface temperature of 52°C, with no need for external controls. In the fully loaded towel warming mode it will act to reduce power and save running costs. In space heating mode it will increase the power to deliver background heat needed to the maximum of its rated capacity. A safe to touch system, with safety measures incorporated.

Element Cable Length 1.0 MTR



## App Controlled Heat Element (Remote control option)

IPX4 suitable for zones 1 and 2 of the bathroom. Negative Temperature Coefficient technology. 7 day programmable element with remote control or in-app control switches the towel rail on and off when you want, at the temperature you want. Eco, boost and safety lock features included, and manual override allows you total flexibility when needed. Can be retro fitted to existing electric or dual fuel multirail towel warmers. Remote control sold separately.



Element Cable Length 1.4 MTR

\*Please note, Element only suitable for vertical installation



## Contract Fixed Heat Electronique Element

IP55 Suitable for zones 1 and 2 of the bathroom. Fixed Heat is designed as an energy saving element to control temperature and consume only the correct amount of power required. It maintains your pre-set temperature whether the rail is in a cold bathroom empty or fully loaded with towels. Fixed Heat for LST (low surface temperature) of 43°C must be chosen to comply with LST legislation for use in public buildings, hospitals and care homes.

Element Cable Length 1 MTR

Product	Watts	£ ex VAT	£ inc VAT
---------	-------	----------	-----------

STANDARD ELEMENT			
EE002	50	61.00	73.20
EE002	75	64.00	76.80
EE002	100	101.00	121.20
EE002	125	103.00	123.60
EE002	150	104.00	124.80
EE002	200	106.00	127.20
EE002	300	107.00	128.40
EE002	400	108.00	129.60
EE002	600	113.00	153.60

HEAT SENSOR ELEMENT			
EE006	200	182.00	218.40
EE006	300	193.00	231.60
EE006	400	201.00	241.20
EE006	600	212.00	254.40
EE006	800	221.00	265.20
EE006	1000	234.00	280.80

HEAT SENSOR COVER SHROUD			
AC040	N/A	18.00	21.60

ELECTRONIQUE ELEMENT			
EE001A	200	235.00	282.00
EE001A	400	246.00	295.20
EE001A	600	263.00	315.60

APP CONTROLLED HEAT ELEMENT (REMOTE OPTION)			
EE005	300	223.00	267.60
EE005	600	226.00	271.20
REMOTE CONTROL (ONLY)	N/A	66.00	79.20

CONTRACT FIXED HEAT ELECTRONIQUE ELEMENT			
EE001C	200	235.00	282.00
EE001C	400	246.00	295.20
EE001C	600	263.00	315.60



Summer kits are available for dual fuel options.



## AC003

Conversion tee for dual energy radiators. Also available in Matt Black and Anthracite from £39 ex VAT and £46.80 inc VAT

# HEATING OPTIONS

## HEATING ONLY OPTIONS

H

Is suitable for all heating and hot water systems. For connection to either direct (open) or indirect (closed) central heating systems.

C

Suitable for indirect (closed) central heating circuits only. It cannot be installed on an open circuit due to the product containing ferrous (steel)



Standard Rail Option (H) and (C)



Multirail Option (H) and (C)

## ELECTRIC ONLY OPTIONS

E

A completely independent unit requiring only a fused spur electric connection. Thermal transfer fluid is heated by an electric element



Standard Rail Option (E)



Multirail Option (E)

## DUAL FUEL OPTIONS

D

The towel rail has the capability to run from a central heating circuit or an electric element. Handy in the summer months when the central heating is turned off.



Standard Rail Option (D)



Multirail Option (D)

## ELECTRIC DRYLINE OPTION

DL

Electric dryline technology, with the towel warmer not containing any fluids. The towel warmer is heated using a silicone heater cable, exiting the towel warmer via a three core cable. This can then be attached to a fuse spur. Only available on specific models, please contact our sales office on +44(0)1902 387000 for further details. POA.



### Please Note:

When using the electric element only (i.e.; during summer), allowance must be made for thermal expansion within the product by having the 'return' radiator valve left partially open. The 'flow' radiator valve must be closed to prevent back flow through the system. Both valves should be opened and balanced when the central heating system is operative, (i.e. during winter). Steel Rails - Must be installed in accordance with B57593 where a corrosion inhibitor is used. Brass Rails - Caution where water softener is installed, as this could cause dezincification (material is attacked i.e. zinc eaten away by aggressive water).

Brass towel warmers are manufactured using dezincification resistant brass, however it should be understood that the term 'resistant' does not entirely preclude the possibility of dezincification occurring. If you intend to install the product on an open (DHW) circuit, make reference to your local water authority to ensure dezincification has not previously occurred. Towel warmers manufactured from brass tubing should not be installed on an open circuit if a water softener is present. Water analysis to determine the likelihood of dezincification is available at cost. Models suitable for indirect (closed) circuits only cannot be installed on an open circuit due to the item containing ferrous (steel) parts. Product compatibility is the responsibility of the installer.

# FITTED BY US

## ELECTRIC & DUAL FUEL PRICES

This section contains a range of elements with price supplements for electric and dual fuel models. Please add the price of your element to the model you choose and we will build it for you.



### Standard Element IP55

A benchmark element to suit each size of product.

- E** Electric Only £201.00 ex VAT, £241.20 inc VAT
- D** Dual Fuel £138.00\* ex VAT, £165.60 inc VAT

**Code EE002**



### Heat Sensor Element IPX5

An electronic temperature sensor control.

- E** Electric Only £296.00 ex VAT, £355.20 inc VAT
- D** Dual Fuel £244.00\* ex VAT, £292.80 inc VAT

Optional cover shroud available AC040 £18.00 ex VAT £21.60 inc VAT

**Code EE006**



### Electronique Element IP66

Maintains surface temperature of product to 52 °C.

- E** Electric Only £314.00 ex VAT, £376.80 inc VAT
- D** Dual Fuel £259.00\* ex VAT, £310.80 inc VAT

**Code EE001A**



### Contract Fixed Heat Electronique Element IP55

Ideal for LST applications where surface temperatures need to be guaranteed.

- E** Electric Only £314.00 ex VAT, £376.80 inc VAT

**Code EE001C**



### App Controlled Heat Element IPX4 (Remote control option)

Negative Temperature Coefficient technology. App controlled phone / tablet. Optional remote controlled.

- E** Electric Only £331.00 ex VAT, £397.20 inc VAT
  - D** Dual Fuel £269.00\* ex VAT, £322.80 inc VAT
- Remote Control £66.00 ex VAT, £79.20 inc VAT

**Code EE005**



\* Dual fuel models will also be supplied with a conversion tee where applicable. This can be used with VL013 valves for a multitrail. Alternatively, to a conversion tee dual fuel valves VL015 can be used. All the images of elements depict electric only versions. Dual fuel configurations may vary including element positioning. The appropriate standard versions will be supplied in all cases unless advised otherwise. Electric towel warmers are filled with a glycol ethylene / water mix to strict guidelines. This improves the thermal transfer rate and acts as a corrosion inhibitor. All electric and dual fuel towel warmers must be fitted by a qualified person. The elements are fitted on the right hand side as standard. They can be left hand mounted on request, on certain rails only. Dual Energy units are supplied with matching tee pieces wherever possible. Please consult with Sales to confirm suitability and pricing for your own requirements.

# UNIVERSAL TOWEL RAIL SHELF

Available left or right handed to suit, Universal towel rail shelves are available in 3 sizes with a choice of White or Anthracite finish. Easy to install with a simple 3 step fix to the wall.



## AC067

Universal Towel Rail Shelf

White

Anthracite

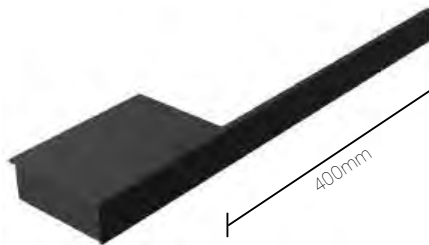
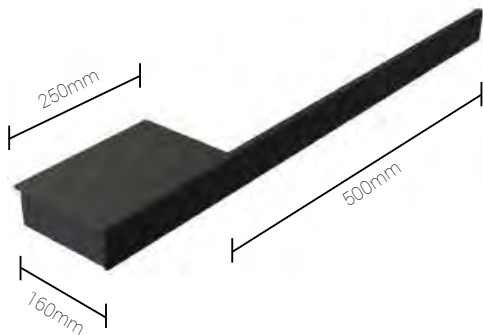

Product		£ ex VAT White / Anthracite	£ inc VAT White / Anthracite	Stock
AC067	300mm Universal towel rail shelf (550mm width with shelf) left or right handed	108.00	129.60	✓
AC067	400mm Universal towel rail shelf (650mm width with shelf) left or right handed	110.00	132.00	✓
AC067	500mm Universal towel rail shelf (750mm width with shelf) left or right handed	112.00	134.40	✓

# ΔT

## DELTA T CONVERSION

### WHAT IS DELTA T?

Delta T, or ΔT, is the difference in temperature between water circulating in the central heating system and that of the room temperature.

If the room temperature is 20°C and the water temperature inside the radiators is 70°C, the value is calculated as:-

Temperature of water inside radiator is 70°C  
Minus the room temperature 20°C  
= (Delta T or ΔT) 50°C.

Delta T 50° is the UK's standard for all domestic boilers.  
It allows you to make a comparison of hydronic radiator and towel rail outputs from various suppliers.

### DELTA T CORRECTION FACTORS - DELTA T 50°

A Delta T correction factor allows you to find out the BTU output of a radiator or towel warmer in the range of Delta T variations.

Example: Assuming a radiator or towel rail has a heat output of 1000 BTUs at ΔT (Delta T) = 50° (1000 x 1 equates to 1000 BTUs)

At ΔT (Delta T) = 40° the output would be 1000 x 0.75 equating to 750 BTUs.

### DELTA T CORRECTION FACTORS - DELTA T 30°

Delta T30 is based on a cooler water temperature of 55°. These temperatures are typical of heat pumps and greener energy methods of heating.

At ΔT (Delta T) = 30° the output would be 1000 x 0.51 equating to 510 BTUs.

Delta T	Correction Factors
75°C	1.69
70°C	1.55
65°C	1.41
60°C	1.27
55°C	1.13
50°C	1
45°C	0.87
40°C	0.75
35°C	0.63
30°C	0.51
25°C	0.41
20°C	0.3
15°C	0.21
10°C	0.12
5°C	0.05

Log onto our BTU Calculator to see how many BTU's your room size needs. [www.vogueuk.co.uk/btu-calculator](http://www.vogueuk.co.uk/btu-calculator)

# IP RATING & BATHROOM ZONES

IEE Wiring Regulations have identified the following zones and IP ratings to ensure safety.



<b>ZONE 0</b>	Inside the bath or shower. Any fitting here must be SELV (max 12V) and a minimum rating of IPX7. (Protection against immersion in water).
<b>ZONE 1</b>	Above the bath or shower to a height of 2.25m. A minimum rating of IPX4 is required * See note 1.
<b>ZONE 2</b>	The area stretching to 0.6m outside the bath or shower and above the bath or shower if over 2.25m. A minimum rating of IPX4 is required * See note 1.
<b>OUTSIDE ZONES</b>	Anywhere outside zones 0, 1, and 2. Where water jets are not used for cleaning purposes, the general rules BS7671 apply. * See note 1.

- In zones 1 and 2 if there is a likelihood of water jets being used for cleaning purposes a minimum of IPX5 is required.
- Where ceiling heights exceed 2.25m, the zones are effectively up to 3m, beyond 3m the walls are out of scope.
- All final circuits require 30mA RCD protection. Information contained on this page is for guidance only. Please refer to current IEE Regulations or a qualified electrician.

## IP Rating Guide

The IP (ingress protection) rating given to an enclosure, states the degree of protection it offers by means of two digits. A summary of these are detailed below. For more information please see British BS EN 60529:1992, European IEC 60509:1989

DUST	MOISTURE
<b>1</b> Protected against solid objects larger than 50mm e.g. touch of a hand.	<b>1</b> Protected against vertically falling drops of water e.g. condensation.
<b>2</b> Protected against solid objects larger than 12.5mm e.g. fingers.	<b>2</b> Protected against direct sprays of water up to 15° from the vertical.
<b>3</b> Protected against solid objects larger than 2.5mm e.g. tools and cables.	<b>3</b> Protected against direct sprays of water up to 60° from the vertical.
<b>4</b> Protected against solid objects larger than 1mm.	<b>4</b> Protected against water splashed from all directions - limited ingress permitted.
<b>5</b> Protected against dust (no harmful deposits).	<b>5</b> Protected against low pressure jets of water from all directions - limited ingress permitted.
<b>6</b> Totally protected against dust.	<b>6</b> Protected against strong jets of water e.g. for use on ship decks - limited ingress permitted.
	<b>7</b> Protected against the effects of temporary immersion in water between 150mm and 1m.
	<b>8</b> Protected against continuous submersion at a specified depth.

**IP65**  
Ingress Protection

IEC 529, bs en 60529 does not apply to any risk of explosion or conditions such as humidity, corrosive gases, fungi or vermin. In certain cases equipment designed to be mounted in an enclosure will contribute towards the stated IP rating (eg Push buttons mounted in an enclosure). Different parts of enclosures can have different degrees of protection and still conform to the standard (e.g. Enclosures with pre-drilled conduit entry). All information strictly for guidance only, please refer to regulations and manufacturers for information if you are in any doubt.

# ACCESSORIES



**AC002**  
Ball vent



**AC003**  
Dual energy conversion tee  
Also available in Matt Black and Anthracite



**AC004**  
Valve sleeves Chrome



**AC005C**  
Valve sleeves White, Anthracite or Matt Black



**AC005**  
Connection tubes



**AC006**  
Street elbow connection tubes



**AC007**  
Electric element shroud covers. Shown as standard in Chrome. Other finishes are available.

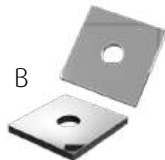

**AC010**  
Round or square metal cover plates

\*Please be aware that some cover shrouds conceal the element block and cable but NOT the service nut. If unsure, please ask your Dealer for more information prior to ordering.



**AC011A or B**  
Arne straight or angled fixing kit  
Also available in contemporary colour finishes



**AC011F**  
Crosshead angled fixing kit



**AC011S**  
Piazza angled fixing kit



**AC012 Voltage Regulator**  
A manual controller to manage power consumption to your towel warmer



**AC013 7 Day Timer**  
Control the time of day the towel rail on



**AC014 Pattress Plate**  
Housing the wires from the towel rail element if no external controller is required

Product		£ ex VAT CHROME	£ inc VAT CHROME
<b>Opposite</b>			
AC002	1/2" BSP M.I. Decorative air vent and plug	107.00	128.40
AC003	Three point 1/2" BSP adaptor. For electric element and radiator valve link	39.00	46.80
AC004	19 mm ø x 100 mm long, electroplated to match towel rail and valves	89.00	106.80
AC005CAT	15 mm ø x 180 mm long, Anthracite to match towel rail and valves	24.00	28.80
AC005CMB	15 mm ø x 180 mm long, Matt Black to match towel rail and valves	24.00	28.80
AC005CWH	15 mm ø x 180 mm long, White to match towel rail and valves	24.00	28.80
AC005	15 mm ø x 150 mm long	39.00	46.80
AC006	15 mm ø x 250 mm long	56.00	67.20
AC007A	Legacy ball joint	137.00	164.40
AC007B	Contemporary	121.00	145.20
AC007C	Mitred	121.00	145.20
AC007D	Flexi (suitable for use with standard element only)	139.00	166.80
AC007E	Preset (suitable for use with EE001c & EE006)	121.00	145.20
AC007F	Originals ball joint	157.00	188.40
AC007G	Electronique (suitable for use with electronique element only)	121.00	145.20
AC007H	Hexagonal	185.00	222.00
AC010A	Round 15 mm internal diameter hinged cover plates	25.00	30.00
AC010B	Square 15 mm internal diameter cover plates	25.00	30.00
AC011A or B	VL003 (pair) straight or angled valves with cover plates and connection tubes	111.00	133.20
AC011F	VL008 (pair) angled valves with cover plates and connection tubes	137.00	164.40
AC011S	VL0014 (pair) angled valves with cover plates and connection tubes	155.00	186.00
AC012	Chrome 75W - 400W (1 gang)	69.00	82.80
AC012	Chrome 150W - 1000W (2 gang)	143.00	171.60
AC013	Digital single channel programme timer	73.00	87.60
AC014	Covers 1 gang pattress box (Chrome)	38.00	45.60
<b>Below</b>			
AC031	Chrome and frosted sphere. Suitable for MD001, MD003, MD005 and MD034	52.00	62.40
AC035	Oil Aroma Blanking Plug	12.00	14.40
AC040	Heat Sensor Element Cover Shroud	18.00	21.60
AC060	Air vent cap (per pair) to fit over radiator vent & blanking plug	9.00	10.80
AC065	Universal Chrome robe hook. Suitable for MD062, MD063, MD001, MD002, MD006, MD003, MD004, MD034	16.00	19.20



**AC031**  
Clip on frosted sphere  
and Chrome Robe Hook

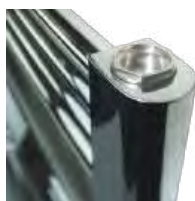

**AC035**  
Blanking Plug with  
Aroma Oil Dish



**AC040**  
Heat Sensor Element Cover Shroud  
Can be used when depth from wall to  
centre is the maximum of 70mm



**AC060**  
Air Vent Cap



**AC065**  
Universal Chrome Robe Hook

**ANGLED VALVES** - Arne VL003 Angled Pair - £51.00 ex VAT, £61.20 inc VAT



Chrome



Anthracite  
Textured



Satin  
Black



Matt  
Black



Steel Blue



Moss Green



White Sparkle  
Textured



Grey Sparkle  
Textured



Espresso  
Gloss



Cappuccino  
Textured



Mocha  
Textured



Latte  
Textured

or

Standard White

**STRAIGHT VALVES** - Arne VL003 Straight Pair - £51.00 ex VAT, £61.20 inc VAT



Chrome



Anthracite  
Textured



Satin  
Black



Matt  
Black



Steel Blue



Moss Green



White Sparkle  
Textured



Grey Sparkle  
Textured



Espresso  
Gloss



Cappuccino  
Textured



Mocha  
Textured



Latte  
Textured

or

Standard White

**CORNER VALVES** - Arne VL023 Corner Pair - £61.00 ex VAT, £73.20 inc VAT



Chrome



Anthracite  
Textured



Satin  
Black



Matt  
Black



Steel Blue



Moss Green



White Sparkle  
Textured



Grey Sparkle  
Textured



Espresso  
Gloss



Cappuccino  
Textured



**NEW**

Compact & discreet option.

**NEW**

**ANGLED FOCUS METALLICS** - Arne VL033 Angled - £51.00 ex VAT, £61.20 inc VAT



Focus  
Satin Brushed Nickel



Focus  
Brushed Bronze



Focus  
Brushed Brass



Focus  
Gunmetal

**NEW**

**STRAIGHT FOCUS METALLICS** - Arne VL033 Straight - £51.00 ex VAT, £61.20 inc VAT



Focus  
Satin Brushed Nickel



Focus  
Brushed Bronze



Focus  
Brushed Brass



Focus  
Gunmetal

**NEW**

**CORNER FOCUS METALLICS** - Arne VL043 Corner - £61.00 ex VAT, £73.20 inc VAT



Focus  
Satin Brushed Nickel



Focus  
Brushed Bronze



Focus  
Brushed Brass



Focus  
Gunmetal



Focus Metallics Finishes - AC005D - £24.00 ex VAT, £28.80 inc VAT

**NEW**

**CONNECTION TUBES  
& COVER PLATES**

Finishing touches to complete the look.



Colours to match stocked valves options - AC005C - £24.00 ex VAT, £28.80 inc VAT

## THERMOSTATIC VALVES & OTHER STYLES



**Arne Thermostatic VL004**  
Straight or Angled Chrome



**Arne Thermostatic VL004**  
Straight or Angled Matt Black  
or Anthracite



**Arne Thermostatic VL004**  
\*Angled only. Focus Brushed Brass



**Arne Corner Thermostatic VL024**  
Chrome



**Arne Corner Thermostatic VL024**  
Matt Black or Anthracite



**Adapta VL001**  
A contemporary double  
angled valve, almost not to  
be noticed



**Xero VL012**  
This modern tap head style suits  
many bathroom taps and fittings



**Piazza VL014**  
Great for square  
tube products



**Combination Kit VL013**  
Straight and angled valves for a  
dual energy option, applicable for  
all multirail products



**Art Deco VL006**  
Great for hexagonal  
tube deco designs



**Crosshead VL008**  
Suits most traditional designs



**Crosshead 2 VL018**  
A capstan style valve suiting  
ball jointed products



**Excelsior VL010**  
Thermostatic, a substantial valve  
in a time honoured design

Valve	Description	Type	£ ex VAT	£ inc VAT	Stock Item
Arne Thermostatic VL004	Chrome 1/2" BSP X 15 mm thermostatic	Straight	79.00	94.80	✓
Arne Thermostatic VL004	Chrome 1/2" BSP X 15 mm thermostatic	Angled	79.00	94.80	✓
Arne Thermostatic VL004	Matt Black 1/2" BSP X 15 mm thermostatic	Straight	79.00	94.80	✓
Arne Thermostatic VL004	Matt Black 1/2" BSP X 15 mm thermostatic	Angled	79.00	94.80	✓
Arne Thermostatic VL004	Anthracite 1/2" BSP X 15 mm thermostatic	Straight	79.00	94.80	✓
Arne Thermostatic VL004	Anthracite 1/2" BSP X 15 mm thermostatic	Angled	79.00	94.80	✓
Arne Thermostatic VL004	Focus Brushed Brass 1/2" BSP X 15 mm thermostatic	Angled	85.00	102.00	✓
Adapta VL001	1/2" BSP X 15 mm	Angled	75.00	90.00	✓
Xero VL012	1/2" BSP X 15 mm	Angled	54.00	64.80	✓
Piazza VL014	1/2" BSP X 15 mm	Angled	90.00	108.00	✓
Combination Kit VL013	1/2" BSP X 15 mm	Angled / Straight	63.00	75.60	✓
Art Deco VL006	1/2" BSP X 15 mm	Angled	81.00	97.20	✓
Crosshead VL008	1/2" BSP X 15 mm	Straight	66.00	79.20	✓
Crosshead VL008	1/2" BSP X 15 mm	Angled	66.00	79.20	✓
Excelsior VL010	1/2" BSP X 15 mm thermostatic	Angled	194.00	232.80	✓
Crosshead 2 VL018	1/2" BSP X 15 mm	Angled	54.00	64.80	✓
Arne Corner Thermostatic VL024	Chrome 1/2" BSP X 15 mm thermostatic	Corner	90.00	108.00	✓
Arne Corner Thermostatic VL024	Matt Black 1/2" BSP X 15 mm thermostatic	Corner	90.00	108.00	✓
Arne Corner Thermostatic VL024	Anthracite 1/2" BSP X 15 mm thermostatic	Corner	90.00	108.00	✓
Dual Fuel VL015	1/2" BSP X 15 mm	Angled	62.00	74.40	✓



**Dual Fuel Valves VL015**

For both central heating and electric dual fuel options



**Straight Valves**



**Angled Valves**

All valves are supplied as standard in a chrome finish. Other finishes are available.

Please Note: Designs may differ slightly when ordering in different finishes. Please contact our sales office on 01902 387000 to discuss your requirements.



## METALLIC FINISHES

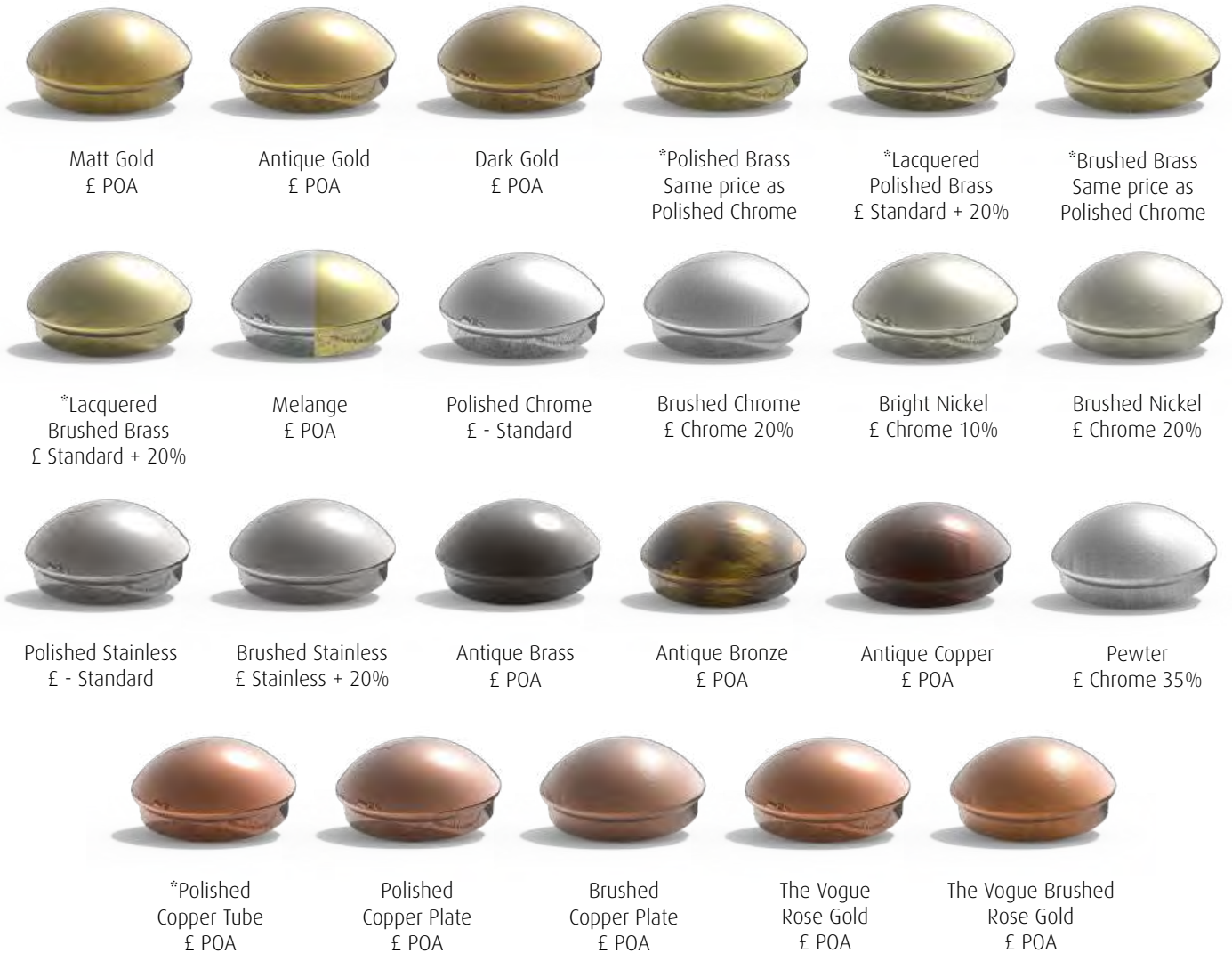

**Please Note:** Polished Brass and Polished Copper tube finishes, are supplied in a raw, un-lacquered finish, as standard. This un-lacquered (ie; unprotected) base material will discolour in a short period of time and will therefore require regular cleaning in order to maintain the finish. To add a lacquer to preserve the finish, add an additional 20% to the un-lacquered price. Brushed Brass will be supplied as a lacquered finish only and subject to an additional 20% supplement charge on top of the chrome finish price.

The supplements displayed on this page are only to be added to brass manufactured towel rails, please see the individual product page for full material information. Individual mild steel supplements can also be found on the product page. For more information regarding pricing contact sales on 01902 387 000.

Antique Bronze, Tuscan & Antique Copper - Due to the reaction between the solution with the base metal there will always be a degree of natural variation in shading between different components.

## PAINTED COLOURS AND FINISHES

The colours and finishes below are available on many of our ranges carrying the RAL colour symbol. The featured colours have a £279.00 supplement ex VAT, on the white price. Other RAL colours are available POA.



## CONTEMPORARY COLOUR RANGE



The contemporary colour range is available as a stocked item in three models Serene, Vela and Focus. White & Grey Sparkle Textured, Latte, Cappuccino, Mocha and Anthracite have a textured finish, with Espresso and Satin Black being gloss. These finishes are also available on other ranges.

## RADIATOR COLOURS

Choose from literally hundreds of colours from the RAL Colour Chart - POA

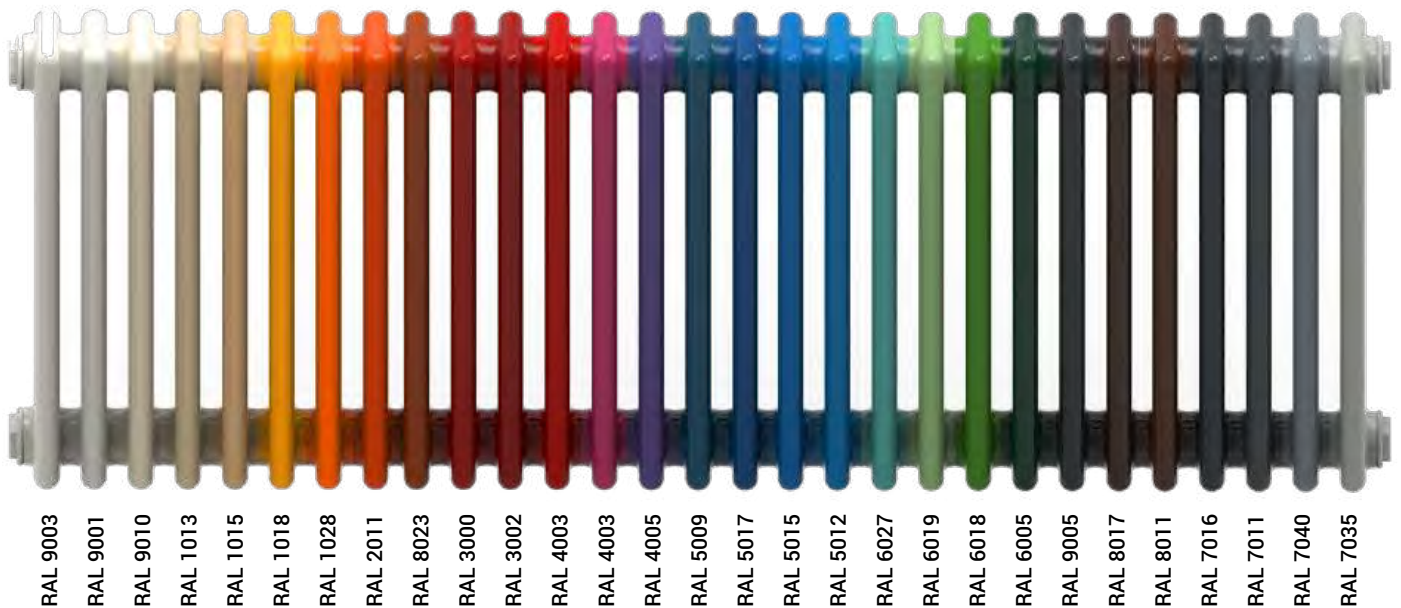

# TUBING AND JOINTS

Selecting your joint and tube design could not be more flexible.

Our handmade selection of towel warmers can be as individual as you are.

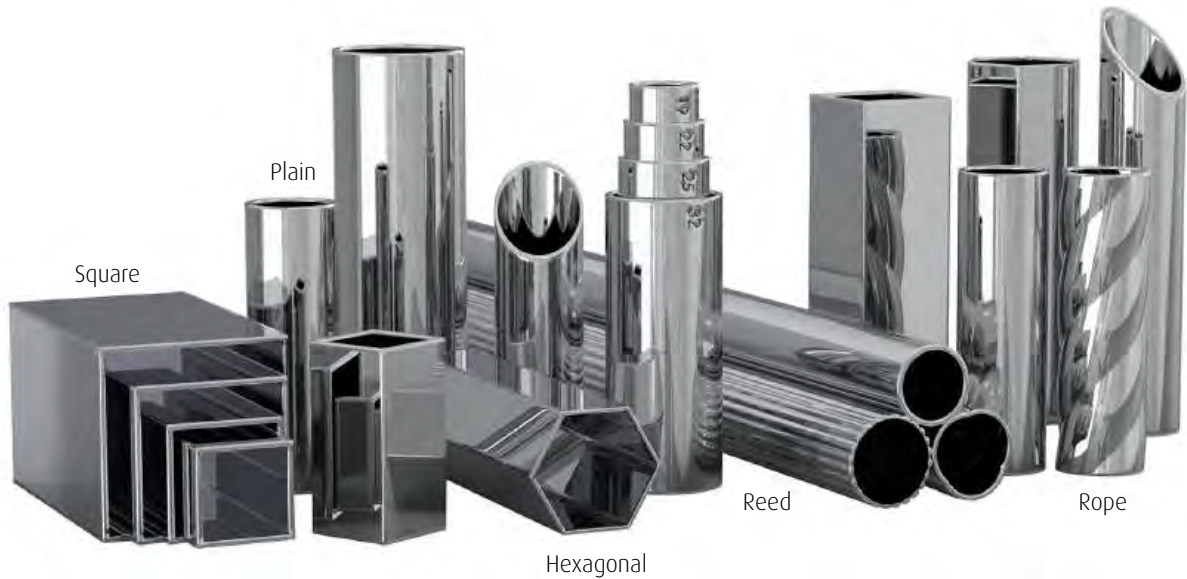

## VOGUE UK JOINT RANGE

Manufactured with pride and precision for your perfection



Ball Joint 1"



Legacy Ball Joint 1.25"



Originals Ball Joint



Charlotte Ball Joint 1.5"



Grandeur Joint



Cylinder Joint



Art Moderne Corner



Minama Square Corner



Romolo Joint



Art Linea Joint



Mitre Corner



Plain Corner



Contemporary Corner



Minama Round Corner



Valour Bend

## GENERAL INFORMATION

Bespoke items are non-returnable. Please note that certain non-stock models are also non-returnable, please confirm with our Sales Office on telephone +44(0)1902 387000.

All heat outputs are shown at 50°CΔt, in compliance with BSEN442 - Specification for Radiators and Convectors. To convert to 60°CΔt, multiply heat output by conversion factor 1.264 (approximate figure), to convert to 70°CΔt, multiply heat output by conversion factor 1.549 (approximate figure).

All measurements given are nominal dimensions only (mm) and are not binding. Detailed technical drawings are available on request from our Sales Office on +44(0)1902 387000 or via our website - www.vogueuk.co.uk Manufactured from hot brass stamped fittings and high quality brass tube complying to BS EN 12449:2016+A1:2019. Some models are manufactured from high grade CR steel tubing and/or containing steel components suitable for closed/indirect circuits only.

All rails are pressure tested to at least 5.4 bar (78psi) up to a maximum of 13 bar (189psi) air immersed in water. All models are fitted with two ½" BSP F.I. connections. Alternative M.I. or compression fitting is available on request. ¾" BSP F.I. connections are available at extra cost on some models. A manual bleed air vent is fitted to all hot water/dual fuel models. Auto air vents are available on request at additional cost.

In compliance with our policy of constant improvement, we reserve the right to alter specifications, materials and dimensions or discontinue any of our products without prior notice. The colours in the brochure are as accurate as the colour printing processes allow. Photographs and images are for illustrative purposes only. We reserve the right to change specifications without prior notification.

Products ordered incorrectly or where the specification has changed will incur a restock charge. Bespoke/custom made products are non-refundable. Upon the return of a product Vogue (UK) Ltd reserves the right to refuse credit if the product is not made available upon an agreed collection/return in line with the Company's terms and conditions. A copy of the Company's full Terms and Conditions of Trading is available on request.

## INSTALLATION

Vogue (UK) Ltd recommends that preparatory work such as the adjustment of existing pipework, the installation of new pipework, or the advance drilling of holes, etc. is not carried out until the towel warmer or radiator is on site and positioned for fitting.

Pipe centres are provided as a centre to centre tapings using the Vogue (UK) range of valves. Valves are NOT supplied with each product. Please see Valves & Accessories section for further details.

All installations of a Vogue (UK) Ltd towel warmer or radiator should be in accordance with the following British Standards;

- BS 7593:2019 Code of Practice for the preparation, commissioning, and maintenance of domestic central heating and cooling water systems  
(In short, clean, protect, test & maintain).
- BS EN 14336:2004 Heating systems in buildings – Installation and commissioning of water-based heating systems
- BS EN 12828:2012 Heating systems in buildings – Design for water-based heating systems.

## EN442.1 & 2

Where applicable product within this publication has undergone independent testing to verify heat outputs are in accordance with the parameters laid down in the above European standards.

## EN60335

Household and similar electrical appliances. Safety. Part 2 - 43 : 2003 + A2 : 2008. Where applicable all product within this publication utilising an electrical heating component, conform to the above safety standard.

## ISO 9001:2015 CERTIFIED

Vogue (UK) Ltd is proud to be ISO 9001: 2015 certified.

Quality is utmost in importance to our organization, in both the products and services we provide our customers. Reflecting this commitment, Vogue (UK) Ltd implemented and received certification of our Quality Management System in accordance with ISO 9001:2015.

## CONSTRUCTION PRODUCT REGULATIONS (CPR)

In compliance with the above, Vogue (UK) Ltd (The company) holds declaration of Performance Certificates (DoPs) for all products covered by the Harmonised Standard EN442.1 / 2. Copies of relevant certificates are available on request. Some products at the time of print may be awaiting confirmation.

Product with a declared heat output of 200 Watt or less 50 degree C Delta T are not classified by The company as heating appliances and are therefore not covered by the above. All individually manufactured bespoke products are similarly exempted from the above legislation.

## WARRANTY

Vogue (UK) Ltd is a company that celebrates the wealth of traditional, quality handcrafted heated towel warmers and radiators and is one of the last true manufacturers in the UK. Vogue branded towel warmers supplied and installed within UK are also covered by an extended 2, 15, or 30 Year product warranty –subject to our business trading Terms & Conditions against manufacturing defects. Components such as inset radiators, not of our manufacture, which become faulty by reason of defected materials, come with a 2 year warranty only.

## CONTINUAL IMPROVEMENT

Our company policy is one of continual improvement and Vogue (UK) Ltd reserves the right to amend designs, specification or discontinue any of our products without prior notice.

E & OE.

## CARRIAGE

Paid UK mainland, excluding requests for next day service, Export carriage can also be arranged. Please contact our Sales Office for details on telephone +44(0)1902 387000.



# INDEX

Model	Code	Material	Section	Style	Installation	Page
<b>A</b>						
Accessories	AC		A			131
Amie	CN065	MS	CN	MTW	WM	18
Arc Chrome	MD065	MS	CN	MTW	WM	14
Arc Matt Black	MD065	MS	CN	MTW	WM	13
Arcadia	LG017/OG017	MS/BR	TR	TTW	FM	79
Art Moderne	OG011	BR	TR	TTW	FW	93
Art Moderne	OG010	BR	TR	TTW	WM	94
Astute Compact	DR034	AL	DR	DR	WM	116
Astute Horizontal	DR036/DR036DP	AL	DR	DR	WM	115
Astute Towel Warmer	CN095	AL	CN	MTW	WM	51
Astute Vertical Double	DR035DP	AL	DR	DR	WM	118
Astute Vertical Single	DR035	AL	DR	DR	WM	117
Aquila Chrome	DR016	MS	DR	DR	WM	21
Aquila Matt Black	DR016	MS	DR	DR	WM	22
Axis Chrome	MD062	MS	LR	MR	WM	55
Axis Matt Black	MD062	MS	LR	MR	WM	56
<b>B</b>						
Ballerina	LG024A-MS/ LG021-MS	MS	TR	TTW	FW	83
Ballerina	LG024/LG021/ OG003	BR	TR	TTW	FW	82
Ballerina	LG010-MS CP	MS	TR	TTW	WM	84
Ballerina	LG010-MS MB	MS	TR	TTW	WM	85
Ballerina	LG010-MS FBB	MS	TR	TTW	WM	86
Ballerina	LG025/LG010/ LG021/OG002	BR	TR	TTW	WM	81
Baroque	LG014/OG016	BR	TR	TTW	FM	80
Basin Stands		BR	TR	TTW	FW/WM	101
Bathroom Zones			A			138
Binary	TR002	BR/MS	CN	S	WM	46
Boxa	CN009	MS	CN	MTW	WM	31
Butler	LG035/OG004	BR	TR	TTW	FW	89
<b>C</b>						
Chic	MD046	MS	CN	DTW	WM	19
Chorus	MD002	MS	LR	MR	WM	60
Chube	MD035	SS	LR	MR	WM	65
Colour options			A			146
Combes	MD063	MS	LR	MR	WM	57
Concord	DR041	MS	CN	DTW	WM	52
Contrast	MD079	MS	CN	MTW	WM	15
<b>D</b>						
Décor Harmonique	MD094	MS	CN	RTW	WM	50
<b>E</b>						
Eco Modular Bars ELTB12V		SS	E	MTW	WM	125
Electric Element & Dual Fuel Fitted Pricing			A			135
Electric Element Only	EE001/EE002/ EE003/EE005/EE006		A			133
Electric Under Floor Heating	EUFH		E	UFH		127
Elizabeth	LG003/OG019	MS/BR	TR	TTW	FW	91
Elizabeth	LG003/OG019	BR	TR	TTW	WM	92
Envirovent Electric Fans	SILD/ECODMEV/ SILM/SILENT		E			129

Model	Code	Material	Section	Style	Installation	Page
<b>F</b>						
Fairing	PJ010A PJ021B/PJ021C	BR	TR	TTW	WM	95
Fly Line Horizontal	DR004/DR004DP	MS	DR	FR	WM	110
Fly Line Vertical	DR003/DR003DP	MS	DR	FR	WM	109
Fly Line II Horizontal	DR002/DR002DP	AL	DR	FR	WM	112
Fly Line II Vertical	DR001/DR001DP	AL	DR	FR	WM	111
Focus	MD001	MS	LR	MR	WM	59
Focus Colour Range	MD001	MS	LR	MR	WM	61
Focus Metallics Range	MD001	MS	LR	MR	WM	62
Focus Horizontal	MD001H	MS	LR	MR	WM	63
<b>G</b>						
Galaxy	MD059	SS	LR	MR	WM	68
Gallant	MD040SS	SS	CN	MR	WM	33
Gallant II	MD040MS	MS	CN	MR	WM	34
Grace	MD067	MS	CN	MTW	WM	16
Grandeur	GD032FW	BR	TR	TTW	FW	87
Grandeur	GD032WM	BR	TR	TTW	WM	88
<b>H</b>						
Hamlet	LG037/OG001	BR	TR	TTW	WM	90
Harmonique	MD060	MS	CN	RTW	WM	49
Heating Options			A			134
<b>I</b>						
Ideal	MD055	SS	CN	MTW	WM	28
Ieri	TM014-BR	BR	CN	S	WM	44
<b>J</b>						
Joints & Tubing			A			147
<b>K</b>						
Kerve	MD036	SS	LR	MR	WM	66
Keys II	CN030	MS	CN	DTW	WM	20
<b>L</b>						
Lure Double	DR020DP	MS	DR	DR/VT	WM	114
<b>M</b>						
Mantra V	CN075	MS	CN	MTW	WM	43
Marine	DR009	MS	CN	DR/ DTW	WM	12
Melody	MD004	MS	LR	MR	WM	70
Metallic Finishes			A			145
Mode Accessories	AC					123
Mode Bespoke	2C/3C/4C/5C/6C	MS	DR	C	WM	123
Mode Column Radiator	2C/3C/4C	MS	DR	C	WM	121
Mode II	CN027	MS	DR	C	WM	119
<b>N</b>						
Nexus Grand III	TM003	BR	TR	RTW	WM	97
Nexus III	TM001	BR	CN	RTW	WM	48
<b>O</b>						
Ordinate	MD005	MS	DR	VT	WM	108
Oriel	AU052	AL	DR	C	WM	107

Model	Code	Material	Section	Style	Installation	Page
<b>P</b>						
Pearl	MD058	SS	LR	MR	WM	67
Penthouse	LG018/OG020	BR	TR	MR	WM	96
Pure	MD037	BR	CN	MTW	WM	17
<b>Q</b>						
Quadrate	MD074	MS	CN	MTW	WM	25
Quadrate Harmonique	MD078	MS	CN	RTW	WM	26
<b>R</b>						
Regency	LG004-MS	MS	TR	TTW	FW	73
Regency	LG004-BR/ OG006-BR	BR	TR	TTW	FW	74
Regency	LG005/OG015	MS/BR	TR	TTW	WM	75
Regency II	LG036/OG009	BR	TR	TTW	WM	76
Regency Tall	LG013-MS	MS	TR	TTW	FW/WM	77
Regency Tall	LG013-BR/ OG007-BR	BR	TR	TTW	FW/WM	78
Rhomba	AU039	AL	CN	MTW	WM	24
Rubik	MD038	SS	CN	MTW	WM	27
<b>S</b>						
Sequel III	TM005	BR	TR	RTW	WM	99
Sequel V	TM006	BR	TR	RTW	WM	100
Serenade	DR008	MS	DR	FR	WM	113
Serene	MD049	MS	CN	MR	WM	29
Shower Curtain Rails	SCR1 - 6	BR	TR		WM	103
Sierra	DR040	MS	CN	MTW	WM	11
Simplicity II	EL040/EL045	SS	E	VT	WM	126
Simplicity IV	IVCN026	BR	CN	TTW	WM	41
Smooth	CN035	MS	CN	MTW	WM	23
Solo	TR001	BR	CN	S	WM	45
Squire	MD047	MS	CN	MR	WM	30
Studio	MD006	BR	LR	MR	WM	64
<b>T</b>						
Tempo	MD072	MS	CN	MR	WM	47
Tune	MD003	MS	LR	MR	WM	69
<b>U</b>						
Universal Shelf	AC067	MS	A	S	WM	136
<b>V</b>						
Valves	VL		A			141
Vela	MD048	MS	CN	MR	WM	35
Vela F-Brushed Brass	MD048	MS	CN	MR	WM	36
Venture	CN022	BR	CN	TTW	WM	42
Vintage	LG010B	BR	TR	TTW	WM	98
Vivid	CN021	BR	CN	TTW	WM	37
Vivid II	CN029	BR	CN	TTW	WM	38
Vivid IV Single Bar	IVCN021	BR	CN	TTW	WM	40
Vivid IV Horizontal	IVCN021	BR	CN	TTW	WM	39
<b>Z</b>						
Zenith	IN007	SS	CN	DTW	WM	37

### VOGUE (UK) LTD

Strawberry Lane  
Willenhall, West Midlands  
WV13 3RS United Kingdom

+44(0) 1902 387000 sales@vogueuk.co.uk www.vogueuk.co.uk

## INNOVATION

Vogue UK is a vibrant organisation with research being conducted in many technology disciplines. This research results in exciting products as evidenced throughout the design collections we offer. Vogue UK has set itself a clear objective: both through consistent preservation and long tradition of British craftsmanship and meeting its high standards, as well as creating, with its very own innovative heating developments, contemporary design and a heightened passion for detail and perfection.

Those who appreciate lasting value derived from the synergy of traditional craftsmanship, creative development and the latest technology, as well as dedication in seeking the extraordinary know not to entrust any towel rail design but rather to a design crafted from Vogue (UK).

Vogue UK emphasises its creative drive to differentiate its towel rail designs down to the finest detail and its desire to monitor, to the greatest possible extent, the development and manufacture of a hand crafted product. We use the latest technology to produce low-volume individual parts with high added value continuously offering home interiors and connoisseurs of design new, impressive towel rail models.

## ENVIRONMENT

Vogue UK has a legacy of core values, rooted strongly in safety, health and environmental stewardship. For 30 years, we have been reducing the environmental footprint of our own operations. Today, footprint reduction is expected of all companies. The challenge – and the opportunity – are products and manufacturing processes that are safer, less toxic, more energy efficient, use less water, less energy, and produce fewer greenhouse gases.

We're working to conserve energy and reduce waste and are exploring the use of sustainable materials and products. Whether we're saving costs by reducing energy consumption or creating covetable products through innovative, sustainable design, we believe that reducing our impact on the environment can also result in positive business benefits.

## INDEX KEY

### STYLE

C	Column radiator
DR	Designer radiator
DTW	Designer towel warmer
ER	Electric radiator
FR	Flat Radiator
MR	Multirail
MTW	Modern towel warmer
RTW	Radiator towel warmer
S	Shelf
TTW	Traditional towel warmer
UFH	Under floor heating
VT	Vertical tube

### MATERIAL

BR	Brass
MS	Mild steel
SS	Stainless steel
AL	Aluminium
CI	Cast iron

### SECTION

CN	Contemporary
LR	Ladder rails
TR	Traditional
DR	Designer radiators
E	Electric
A	Additions

### INSTALLATION

FM	Floor mounted
WM	Wall mounted
FW	Floor & wall mounted

Brochure Design



www.loopconcepts.com



**VOGUE UK**

TOWEL WARMERS & RADIATORS

**VOGUE (UK) LTD  
STRAWBERRY LANE  
WILLENHALL, WEST MIDLANDS  
WV13 3RS UNITED KINGDOM**

**T: +44(0) 1902 387000**

**E: [sales@vogueuk.co.uk](mailto:sales@vogueuk.co.uk) W: [www.vogueuk.co.uk](http://www.vogueuk.co.uk)**

**VOGUE UK LTD IS A BUSINESS WITHIN THE BRAND K GROUP OF COMPANIES.**



**ISSUE 7**